

# *Managing Small Fishing Ponds and Lakes in Tennessee*

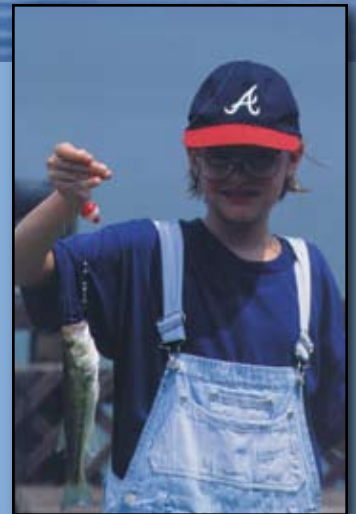

*Tennessee Wildlife Resources Agency*

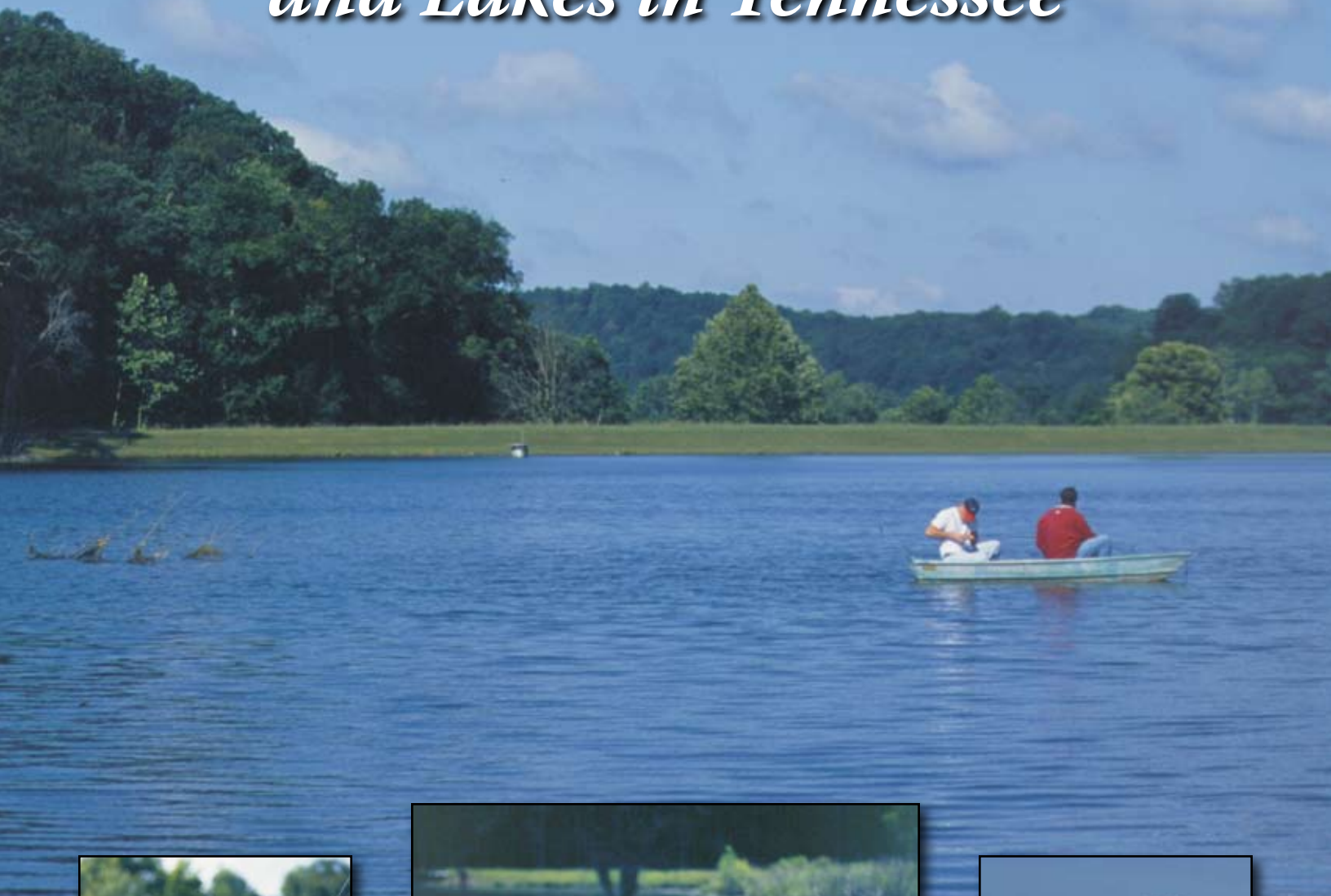
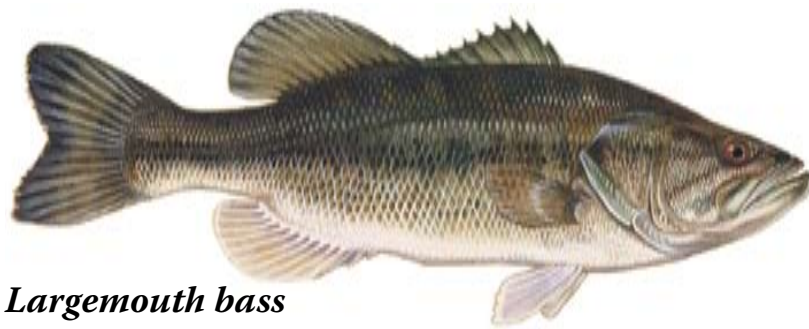

***Largemouth bass***



***Bluegill***



***Redear sunfish***



***Channel catfish***

*(Art by Duane Raver/USFWS)*

*Tennessee ponds stocked with a combination of largemouth bass and bluegill (or bluegill and redear sunfish) offer better year-to-year fishing than any other combination. Channel catfish can also be successfully stocked with this combination of hatchery fish.*





Tennessee has approximately 200,000 small lakes and ponds that provide over 100,000 acres of potential fishing waters. In fact, these waters account for approximately one-fourth of all fishing trips made in Tennessee annually. With proper planning and management, anglers can enjoy years of good fishing on their own property for not only recreational purposes, but to

provide a source of food (fish) for the table. Often times the reason that some ponds and small lakes are unproductive for fishing is the ability of the owner to obtain proper management advice and carry out the recommended practices.

The Tennessee Wildlife Resources Agency (TWRA), in partnership with other state and federal agencies, is committed to

provide information and recommendations in creating sustained fishing opportunities on both private and public lands. This guide is intended to provide landowners the requirements for producing and maintaining quality fishing, and to help them avoid common mistakes that prevent sustained fishing in small lakes and ponds.



*Managing Small Fishing Lakes and Ponds in Tennessee*  
*by the Tennessee Wildlife Resources Agency Division of Fisheries Staff*

*Ninth Revision, 2009*

*Cover photograph by Doug Markham*

This edition of the Tennessee Wildlife Resources Agency's guide to *Managing Small Fishing Lakes and Ponds in Tennessee* is a revision of earlier editions compiled by Mr. Eugene S. Cobb, who is now deceased, and previous Fisheries Division Staff members. Mr. Cobb's and current TWRA fisheries personnel's contributions to this edition are gratefully acknowledged. Additional contributions from the UT Extension personnel and the Natural Resources Conservation Service are also gratefully acknowledged.

Development of this guide was financed in part by funds from the Federal Aid in Sportfish Restoration (Public Law 91-503) as documented in Federal Aid Project FW-6.

Equal opportunity to participate in and benefit from programs of the Tennessee Wildlife Resources Agency is available to all persons without regard to their race, color, national origin, sex, age, disability, or military service. TWRA is also an equal opportunity/equal access employer. Questions should be directed to TWRA, 5107 Edmondson Pike, Nashville, TN 37211, (615) 781-6594 (TDD 781-6691), or to the U.S. Fish and Wildlife Service, Office for Human Resources, 4401 N. Fairfax Dr., Arlington, VA 22203.

Tennessee Wildlife Resources Agency Authorization No. 328838, 10,000 copies, March, 2009. This public document was promulgated at a cost of \$1.23 per copy.

This publication contains recommendations that are based on existing knowledge and are provided only as a guide. They are subject to change at any time. The contributors, Tennessee Wildlife Resources Agency and University of Tennessee Extension assume no liability resulting from the use of these recommendations.

# TABLE OF CONTENTS

## **Pond construction**

Planning.....	1
Permits.....	1
Site.....	1
Soil.....	2
Drainage and water source.....	2
Pond depth, bank slope and shoreline depth.....	2
Dam construction.....	3
Drain pipes.....	3
Spillways.....	4
Fish attractors, habitat and fishing piers.....	4

## **Stocking**

Applying for and getting fish from TWRA.....	5
Fish from commercial sources.....	5
Existing fish in pond.....	5
Measuring pond size.....	5
Fish combinations for stocking.....	6
Fish stocking combinations and rates.....	6
Largemouth bass.....	6
Bluegill.....	7
Redear sunfish.....	7
Channel catfish.....	7
Triploid grass carp.....	7
Fish you should NOT stock.....	8

## **Fertilizing your pond**

Aquatic food web.....	9
Fertilizing to produce more fish.....	9
Types of fertilizer.....	9
Granular fertilizer.....	10
Fertilizing with phosphate alone.....	10
Liquid fertilizer.....	10
Powdered fertilizer.....	10
When to fertilize.....	11
When NOT to fertilize.....	12

## **Liming**

Water testing in existing ponds.....	13
Soil testing for liming rates.....	13
How and when to lime.....	13

## **Aquatic weed control**

Avoiding aquatic weed growth.....	14
Identifying aquatic plants.....	14
Mechanical control.....	15
Chemical control.....	15
Dyes.....	15
Chemical control of nuisance algae.....	16
Applying herbicides and algicides.....	16
Biological control.....	16
Barley straw.....	18

## **Managing fish populations**

Fish population balance.....	20
Avoiding overcrowding.....	20
Pond production and fish harvest.....	21
When to harvest.....	22
Monitoring pond balance.....	22
Monitoring pond balance by seining.....	22
Monitoring pond balance by angling (fishing).....	23
Removing fish from overcrowded ponds.....	24
Partial removal with chemicals.....	25
Partial removal with wire traps.....	25
Partial removal with seines.....	25
Drawdown.....	25

## **Reclaiming unproductive ponds**

Physical characteristics.....	26
Draining pond to reclaim.....	26
Chemical removal of unbalanced fish populations.....	26
Applying rotenone.....	27
When to restock.....	27

## **Fish kills**

Toxic run-off.....	28
Dissolved oxygen.....	28
Aeration.....	29
Diseases and parasites.....	30
Maintaining balance after a fish kill.....	31

## **Feeding fish**

Risks of feeding.....	33
How to feed.....	33

## **Miscellaneous considerations**

Leaking ponds.....	34
Muddy water.....	35
Excess organic matter/foul odors.....	36

## **Livestock and wildlife in fishing ponds**

Livestock.....	37
Wild fish.....	37
Water birds.....	37
Muskrats.....	38
Beavers.....	39
Otters.....	39
Frogs.....	39
Turtles.....	39
Building a turtle box trap.....	40

## **Alternate stocking options**

Catfish-only fishing ponds.....	41
Hybrid sunfish combinations.....	41

CONTINUED ON NEXT PAGE



# TABLE OF CONTENTS (continued)



Photograph by Doug Markham



Photograph by Mike Bramlett



Photograph by Bobby Wilson

## ***Pond measurement***

<i>Determining pond surface acreage.....</i>	<i>42</i>
<i>Determining average pond depth.....</i>	<i>43</i>
<i>Determining water volume (acre-feet).....</i>	<i>43</i>
<i>Other useful conversion factors.....</i>	<i>43</i>

## ***Seeking assistance***

<i>Tennessee Wildlife Resources Agency offices.....</i>	<i>44</i>
<i>U.T. Extension offices.....</i>	<i>45</i>
<i>U.S. Army Corps of Engineers.....</i>	<i>45</i>
<i>Natural Resources Conservation Service.....</i>	<i>45</i>
<i>Tennessee Department of Environment and Conservation.....</i>	<i>45</i>

<b><i>Index</i></b> .....	<b><i>46</i></b>
---------------------------	------------------

# POND CONSTRUCTION

To avoid costly mistakes, seek assistance from experts with state and federal agencies when planning and constructing your fishing pond.

If you plan to participate in the TWRA fish stocking program, your pond construction or renovations should be completed, and water in the pond by early October. See Stocking (5).

To maintain good fishing quality, you should build a pond that is at least 1 surface acre or larger.

## Planning

Deciding where and how to build your pond may be the most important decisions you make when planning pond construction. With proper planning and design you can avoid many problems, and enjoy years of fishing with a minimum of maintenance.

The Natural Resources Conservation Service (NRCS) can make recommendations regarding site selection, soil evaluation, pond capacity and layout, runoff rates, spillway requirements, and other engineering aspects. They can usually refer you to reputable pond building contractors that are familiar with design and construction of ponds that meet NRCS specifications. The NRCS publication *Ponds – Planning, Design, Construction* (Agricultural Handbook 590) is available, and contains detailed pond construction information. To avoid costly mistakes, contact the NRCS for expert advice during the initial stages of pond planning. In addition, the University of Tennessee (UT) Extension Service has several pond construction publications available. For questions regarding available cost-share funds for constructing a pond, please contact your local NRCS office. See *Seeking assistance* (45).

If possible, plan to have the pond completed, and filled by early to mid fall to coincide with stocking fish in the fall. To reduce the risk of the pond becoming contaminated with unwanted fish, the pond should be stocked with the chosen species, at the appropriate time, soon after it's filled.

## Permits

In some cases a permit may be required before a pond or small lake is constructed. If a **wetland** or stream will be affected a permit will be required from the U.S. Army Corps of Engineers (COE) and/or the Tennessee Department of Environment and Conservation (TDEC). If an acre or more of ground/soil is going to be disturbed during construction a permit will be required from TDEC. See *Seeking assistance* (45). To ensure that your pond will conform to all state or federal laws, contact these agencies to determine if any permits are required. An additional permit from TDEC may also be required for impoundments that will have a dam height over 20 feet or if the impounded water volume is 30 acre-feet or more. It's also wise to check to see if local county or city ordinances require any permits.

## Site

To maintain good fishing quality, it's recommended the pond have a surface area of at least one acre. The topography should be considered because it affects construction costs and management. The pond should be located where adequate storage volume can be obtained with the least amount of earth fill. If possible, avoid areas with constantly flowing creeks or streams, or near other ponds that can overflow.

The most suitable **watershed** cover is woodlands, followed by grasslands and pasture. The least suitable is row crop and areas with heavy livestock use since the agriculture practices on these adjacent lands can introduce excessive silt, fertilizer, pesticides, herbicides, and animal wastes to the pond. On cropland and pasture sites, it is advisable to plan an adequate buffer of infrequently mowed grasses to help filter out the excess silt, nutrients and chemicals. For ponds used exclusively for fishing, livestock should not have direct access to the pond. However, a gravity-fed water line can be run from the pond to a watering trough below the dam. See *Drain pipes* (3). The NRCS also has other designs that will limit livestock access to the pond and often has programs to help defray the cost



If a wetland or stream will be affected in constructing a pond, you must first contact the appropriate permitting authorities.



---

***A wetland is an area of land that stays saturated (wet) long enough and often enough throughout the year to support wetland vegetation.***

---

Agricultural herbicides and pesticides are extremely toxic to fish and other aquatic life and should not be used in areas that can drain into streams, ponds or lakes.

---

***A watershed is the area of land that drains into a particular body of water.***

---

Tennessee Department of Environment and Conservation Division of Dams regulates and requires a permit for some dams that are over 20 feet high or that hold 30 acre-feet or more of water.

of installing buffers, fencing to limit livestock access, and watering troughs or alternative livestock watering sources.

In preparing the site, remove all brush and trees, particularly those located in shallow areas, along the bank, and where the dam will be located. To enhance fish habitat, clumps of trees, brush or stumps can be left in the deeper parts of the pond or lake, or if initially removed, they can be returned after construction. No more than twenty-five percent of the pond area should have tree/brush cover. If no trees or brush is available for cover, fish attractors can be built during pond construction. See page 4.

To prevent erosion, the dam and pond banks should be fertilized and seeded with an appropriate perennial grass such as bermuda, bahia, or fescue soon after construction. Mulching of the dam, pond banks, and other sloping areas is recommended. The pond basin can also be planted in wheat, rye, millet or other suitable grass once construction is complete. This will reduce erosion and siltation, and jump start the aquatic life once the pond is filled. Pond owners may consult with the UT Extension Service or the NRCS for the grass variety that is best suited for the pond's location and soil type.

### Soil

The soil types of the area should also be considered in site selection of the pond. The ideal area will have sufficient clay and silty-clay soils to build the levees, dam and pond basin. In some cases, soil boring will need to be taken and analyzed to determine suitability. The NRCS can assist in the evaluation of soil suitability, and if necessary, recommend the addition of clay, bentonite or soda ash (sodium carbonate) in order to avoid leaks. In either case, the pond bottom should be compacted well with a sheepsfoot roller. Once the pond basin has been dug, an Extension agent can advise you how to collect soil samples to be analyzed to determine any lime requirements of the pond bottom. See *Liming* (13).

### Drainage and water source

For a pond site where surface runoff will be the main source of water, the drainage area should be large enough to maintain the water level, but not so large that the site may flood. Normally, a pond should have 5-15 acres of watershed drainage for each one surface acre of water. However, 20-30 acres may be necessary if the watershed is wooded. This varies depending on the slope of the land, soil type and the amount and type of plant cover. If the drainage area is too large, it may be necessary to construct a diversion ditch to divert excess water around the pond. Water may also be provided by springs or wells and should be taken into account when determining the amount of drainage area required. Be aware that surface runoff from residential and urban areas may contain fertilizers, pesticides, oils or other chemicals that can adversely affect the pond's aquatic life and water quality. Therefore, be sure to consider the water source and factors that may affect its quality.

### Pond depth, bank slope and shoreline depth

The correct pond depth, slope of the banks and shoreline depth are important when constructing a pond or lake. Ponds with large areas of shallow water (less than three feet deep) can become unbalanced because they give smaller fish a place to escape from being eaten by larger fish. If the larger fish in a pond do not eat enough of the smaller fish, the pond will become overcrowded with smaller fish and the fish will not grow as well as they should. Shallow water areas also encourage unwanted aquatic weed growth, by allowing sunlight to shine to the bottom, which can provide too much escape cover for small fish. An overabundance of aquatic weed growth can raise water temperature, which lowers the amount of oxygen that fish depend on for survival. See *Dissolved oxygen* (28).

**Pond depth** – A fishing pond should have a preferred maximum depth of no more than 10-12 feet, with an average depth of 6-8 feet. Ponds with an average depth of less than six feet increase the chance of aquatic weeds becoming established. Deeper water does not mean more fish in your pond. The water in deeper ponds stratifies or forms layers of water with different temperatures in the summer. The deepest, coolest layer does not mix with the upper, warm layer because the deepest layer is heavier, and can lead to pond “turnover” as discussed on page 29. Fish may not be able to use the deepest layer because it usually does not have

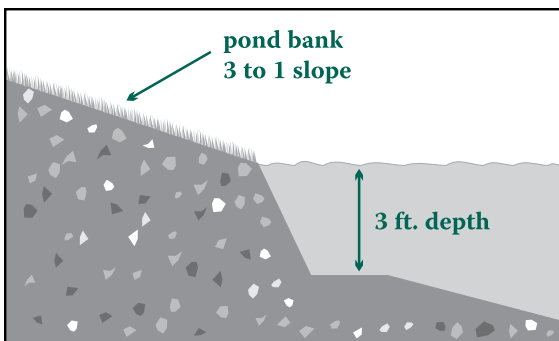

*Slope of pond bank and shoreline depth*



enough oxygen to support fish during the summer. Constructing the pond bottom with irregular features such as humps and channels will enhance fish habitat.

**Bank slope and shoreline depth** – Pond banks should be constructed to slope at a 2:1 or 3:1 ratio. This means you have one foot of vertical rise for every two or three feet of horizontal distance of measurement. The depth at the shoreline should be about three feet to reduce aquatic weed and algae growth that tends to begin growing near the shoreline. See illustration on previous page. From the 3-foot shoreline depth, the pond owner can contour the remaining pond bottom in a way that is desirable to them. If young children will be around the pond, you can ease up on the slope or the shoreline depth can be reduced. A safety ledge could also be constructed at about two feet deep to “catch” a child that may fall in. Be aware that any shoreline depth less than about three feet deep will increase the risk for aquatic weed and algae growth.

### Dam construction

Each fishing pond should have a well built dam, or levee. To prevent seepage and possible cracks, the dam should have a solid clay core and should be at least 8-12 feet wide at the top depending on the height of the dam. The dam should have slopes no steeper than 3:1 on either side (1-foot rise for every three feet of horizontal measurement). Adequate freeboard (distance between water level and the top of the dam) should be incorporated during construction to ensure that water does not flow over the dam during periods of heavy rainfall.

A dam less than 12 feet high should be at least eight feet wide across the top. Dams 12-15 feet high require a 10-foot top width, and those higher than 15 feet require a 12-foot top width. Contact your nearest NRCS office for further information on proper dam construction. See *Seeking assistance* (45).

Trees and other woody plants should be removed from where the dam is going to be built and not be allowed to grow on or near the dam because their roots can cause seepage. They can also attract muskrats, which damage the dam by burrowing. On larger lakes where wave action against the dam may cause erosion, consideration should be given to lining the face of the dam with rip-rip (large rock) or other suitable material about two feet above and below the water level.

### Drain pipes

A fishing pond should be equipped with a drain so the owner can manage overpopulations of bream (bluegill/redear sunfish), control water levels, make repairs and help control unwanted aquatic plants. Although a **drain pipe** is not absolutely necessary, proper pond management is easier and more effective in a pond with a drain pipe. A drain pipe, if installed correctly, will serve as the outlet for most of the water that passes through the pond. Drain pipes are also called overflow pipes. Drain pipes can be made of cast iron, steel, galvanized pipe, corrugated metal, aluminum or PVC. However, those made out of cast iron will not rust out as quickly as corrugated or galvanized pipes will in fertilized ponds, and PVC is prone to breakage.

The drain pipe should include a gatevalve and, to maintain the water level, a standpipe with a grate (trash rack). Grate openings should be small enough to keep larger fish from escaping, but not small enough to trap debris such as leaves. The drain pipe allows the owner to manage for overpopulation of bream.

*A drain pipe, also called an overflow pipe, should provide an outlet for most of the water that passes through the pond.*

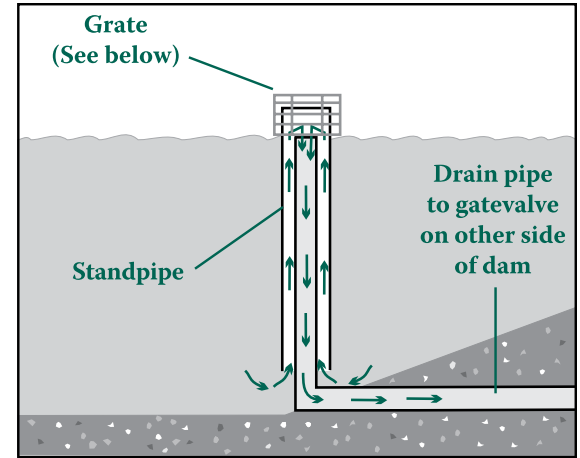

*Drain pipe with a standpipe and grate*

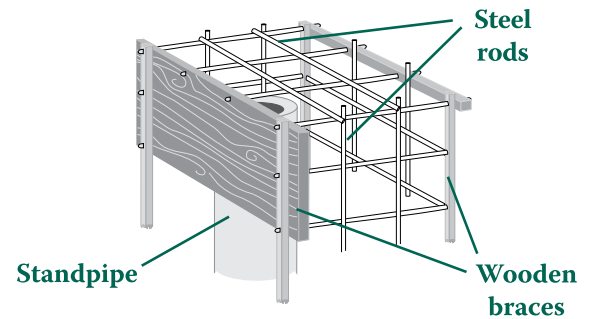

*A grate (trash rack) over the standpipe keeps leaves and fish out of the drain pipe.*

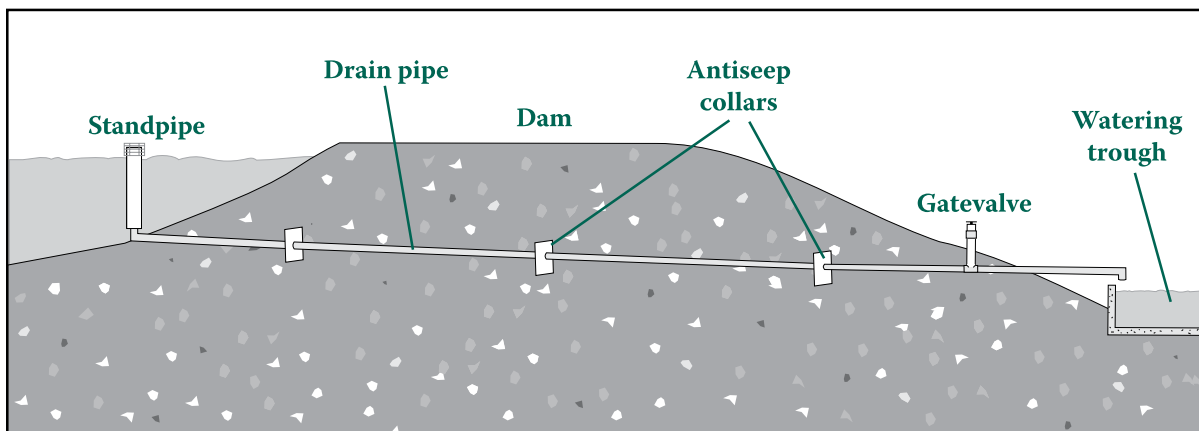

*Gravity-fed drain pipe carrying pond water to a watering trough on the other side of the dam.*

By lowering the water level to concentrate the bream, bass can prey on them more easily. In ponds with severely unbalanced fish populations, a drain pipe can be used to completely drain the pond and start over with new fish. See *Reclaiming unproductive ponds* (26).

Water quality can also be controlled, and occurrences of fish kills can be reduced if stagnant water with low oxygen levels can be drained from the bottom of the pond. Releasing excess water through the overflow pipe reduces the possibility of undesirable, wild fish entering the pond through the spillway. Drain pipes can also be designed to gravity feed pond water to a livestock watering trough below the dam. See illustration on previous page and see *Livestock* (37).

### Spillways

A properly designed **spillway** is essential in all ponds, particularly in ponds not equipped with drain pipes. The length, width and type of spillway is determined by the watershed area, average rainfall, topography, vegetative cover and soil type. To prevent the loss of larger fish, the spillway should be wide enough that excess water flowing out of the pond is never more than 3-4 inches deep. The spillway for an average sized pond (a half- to one-acre) should be between eight and 16 feet wide depending on the size of the watershed and how the land surrounding the pond is being used. The spillway should be constructed about six inches above the level of the overflow pipe with a 3-foot vertical drop on the outflow side of the spillway to prevent entrance of wild fish from downstream. Consult an NRCS agent for information about designing a proper spillway. See *Seeking assistance* (45).

### Fish attractors, habitat and fishing piers

A great way to enhance fish habitat and the fishing experience is to create fish attractors. Fish are attracted to artificial structure because it provides a place where fish can rest, escape from predators and find aquatic insects. It provides you areas where you can usually find fish. It is easiest to add fish attractors right after construction, but they can be added after the pond has been filled with water. Fish habitat can also be enhanced by building a pond with an irregular pond bottom with humps and channels. Fish attractors can be made from a variety of materials such as trees (discarded Christmas trees, cedar trees, willows or hardwoods), or brush piles made of trees and branches anchored down with concrete blocks, stake beds (groups of wooden stakes driven into the pond bottom), rock piles or PVC. Combinations of any of these materials, such as brush piles with stake beds, can also be used. Ready to assemble fish attractors are also available from commercial sources.

When placing brush piles, the more upright (vertically) they stand the better. Several trees grouped together work better than single trees. **Stake beds** can be made by driving 2x2-inch wooden stakes into the bottom or nailing them to a pallet or weighted frame, then sunk. Stakes used for stake beds, whether driven into the bottom or weighted down, should be placed 6-8 inches apart. All fish attractors should be open enough to allow fish to move easily in and around them. This will also make it less likely for hooks and lures to get hung up in them.

Fish attractors should be placed 4-8 feet deep and within fishing distance of the shoreline or piers. They should never be constructed or placed where they could offer too much protection for small fish, which would promote overcrowding. Depending on the size of the attractors, 1-3 fish attractors per surface acre is adequate and when combined, should only take up 10-25 percent of the pond area.

In some cases, gravel beds, which are attractive habitat especially for bluegill to spawn in, can be used as fish attractors. To make a gravel bed, place a three- to five-inch deep layer of ½- to 1-inch gravel into an area that is 2-4 feet deep. Gravel beds 10-14 feet wide are adequate. They should be within fishing distance of the shoreline or piers, and can be added during construction or after the pond is filled.

If you plan to place fishing piers in your pond, remember they are easier to build before the pond is filled with water. Earthen piers, which require almost no maintenance, are another option that should be considered during pond construction.

---

**A spillway is a shallow channel that diverts excess water around the dam so it is not damaged when pond water rises.**

---

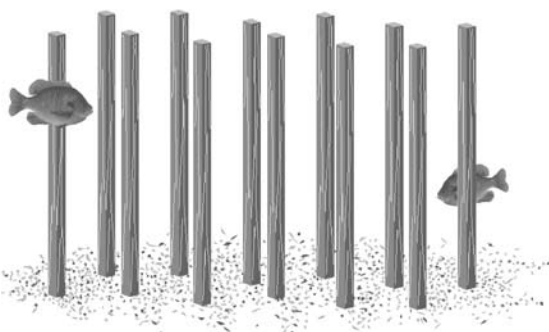

**Stake bed fish attractor**

---

**Stake beds are groups of wooden stakes that can be pounded into the pond bottom or nailed to a pallet, weighted and sunk.**

---

**Trees or brush piles used as fish attractors should be placed as upright as possible and within fishing distance of the shoreline or fishing pier.**

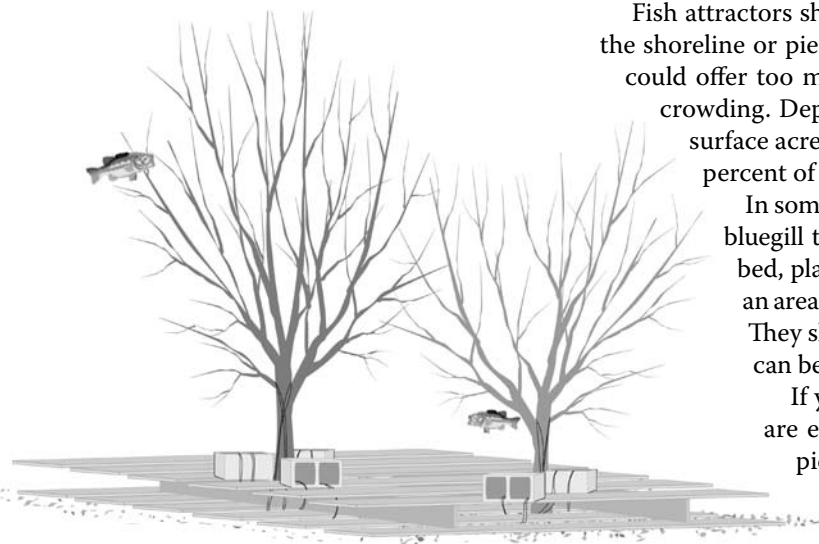

Only apply for TWRA hatchery fish for a new or renovated pond that does not contain fish.

Unless recommended by a fisheries biologist, stocking additional fish in a pond where fishing is already poor will usually not improve fishing.

If you plan to get fish from TWRA, the pond should be at least 25 percent filled with water by early October.

Stock only the species and numbers of fish recommended by a qualified fisheries biologist.

## ***Applying for and getting fish from TWRA***

Currently, only largemouth bass and bluegill are available by application to TWRA for stocking into newly constructed or renovated ponds that are at least 0.25 acres or larger. Applications are available from any TWRA office, at the TWRA Web site, and at many UT Extension Service and NRCS offices. Bluegill are stocked first in October or November, followed by largemouth the following June. A minimal fee is charged, and applications must be postmarked by September 30 to assure fall delivery.

If the application is approved, you will receive a notice approximately two weeks prior to delivery telling you when and where to pick up fish, and what size hauling containers to bring. Fish are distributed to central locations in each region for pickup. Therefore, pond owners must be prepared to make a trip to accept delivery of bluegill in the fall (October or November) and a trip in the spring (June) for largemouth bass.

## ***Fish from commercial sources***

Those who miss the TWRA application deadline can get their hatchery fish from a commercial producer. Many fish producers visit farm and feed supply stores in the county, and some NRCS offices. Further information about purchasing fish from commercial sources can be obtained by contacting TWRA, the UT Extension Service or your local farm supply store. See *Seeking Assistance* (44-45).

## ***Existing fish in pond***

If new or existing ponds become contaminated with wild fish before hatchery fish are available, the wild fish should be eliminated either by draining the pond or with the proper chemicals. If the pond has been stocked previously, corrective action will be necessary before any benefit can be gained from stocking fingerling fish. It is not advisable to stock fish from a neighbor's pond or a local lake, as poor fishing may result. This also increases the risk of introducing a disease into your pond. See *Reclaiming unproductive ponds* (26).

## ***Measuring pond size***

A common mistake made by many pond owners is overestimating the surface area of their pond when applying for fish. If the size of the pond is overestimated, too many fish would be stocked and few would grow to a desired size. If pond size is underestimated, too few fish would be stocked, and the fish population may never achieve proper balance. An approximate measurement of pond size will also be needed if you plan to fertilize, lime or apply herbicides to control aquatic weeds. See *Pond measurement* (42-43).



*Duane Raver, USFWS*



*Duane Raver, USFWS*

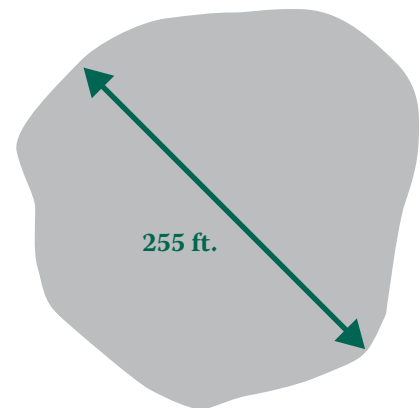

Pond owners should have an approximate measurement of their ponds before stocking.



### ***Fish combinations for stocking***

Although the stocking strategy you choose should be geared to the kind of fishing you want and the pond acreage, Tennessee ponds stocked with a combination of largemouth bass and bluegill (or bluegill and redear sunfish) have provided better year-to-year fishing than any other combination. With TWRA's stocking program, bluegill (bream) are stocked from October through November with bass being stocked the following spring, around June 1. This schedule allows the bluegill to spawn the following spring and provide the forage (food) for the bass fingerlings. Stocking rates for TWRA's stocking program are 500 bluegill and 100 bass per surface acre. This will establish a ratio of 3-5 pounds of bluegill to every one pound of bass in the pond. Depending on the circumstances, ponds can be stocked at other times with fish purchased from commercial sources. Channel catfish can also be stocked in combination with bass and bluegill at rates shown below.

For the best recreational fishing in newly constructed or renovated ponds and small lakes in Tennessee, the recommended species for stocking are largemouth bass, bluegill, (or bluegill and redear sunfish), and channel catfish, if you choose, at combinations and rates listed below. However, other stocking options include stocking channel catfish alone or with hybrid sunfish, or a combination of hybrid sunfish and largemouth bass.

### ***Fish stocking combinations and rates***

Number of fingerling fish per acre a pond owner may choose:

- Largemouth bass and bluegill at 75-100 bass/acre and 500 bluegill/acre.
- Largemouth bass, bluegill and redear sunfish at 75-100 bass/acre, 400 bluegill/acre and 100 redear sunfish/acre.
- Largemouth bass, bluegill and channel catfish at 75-100 bass/acre, 500 bluegill/acre, and 50-75 catfish/acre.
- Largemouth bass, bluegill, redear sunfish, and channel catfish at 75-100 bass/acre, 400 bluegill/acre, 100 redear sunfish/acre and 50-75 catfish/acre.
- Channel catfish-only at 100-150/acre (see *Alternate stocking options* (41).
- Channel catfish and hybrid sunfish at 100 catfish/acre and 400 hybrid sunfish/acre (see page 41).
- Largemouth bass and hybrid sunfish at 30 bass/acre and 750 hybrid sunfish/acre (see page 41).

All the above combinations, except for catfish-only and the hybrid sunfish combinations must be stocked into impoundments larger than 0.25 acres, and preferably at least one acre. In some cases the stocking rates may need to be altered, depending on such things as the pond management plan, extent of fishing, and water quality.

No other fish stocking is necessary after initial stocking, except for supplementary stocking of hybrid sunfish or channel catfish when at least half have been caught out. Adding additional fish, including catfish, to a pond year after year can lead to overcrowding and stunted fish.

### ***Largemouth bass***

Largemouth bass, among the most sought after game fish in North America, are well adapted to Tennessee ponds and lakes. They eat a variety of aquatic organisms including insects, tadpoles, frogs, crayfish and small fish. Larger bass have been known to prey on snakes, turtles, mice and ducklings. They must, however, have fish in their diet to grow to a satisfactory size.

Young bass grow rapidly if enough food is available. Under ideal conditions, a bass can grow 12 inches long in its first year. In most cases, however, they grow only 6-10 inches in their first year. They can grow to be relatively large by the time they are 6-8 years old. Largemouth bass will usually reach spawning maturity when they are from 10-12 inches long. They spawn in the spring when the water temperature reaches 63 to 68° F. The females are generally larger than the males and will produce from 2,000-7,000 eggs per pound of body weight.



***Largemouth bass***

*Duane Raver, USFWS*

## Bluegill

Bluegill, the most commonly stocked bream in Tennessee, have also adapted well to ponds and small lakes. Not only do they provide food for largemouth bass, they provide many hours of angling pleasure and food for the table as well. Bluegill, which mainly eat zooplankton (microscopic animals) and insects, can weigh as much as a pound or more. Most weigh a quarter- to a half-pound and grow to between 4 and 10 inches long. In Tennessee, bluegill begin to spawn in May and will continue spawning throughout the summer when the water temperature is 70-78° F. The female will deposit her eggs in a saucer-shaped nest, or bed, and the male will fertilize and guard them until they hatch. They will hatch in 2-4 days depending on water temperature. A bluegill will produce from 10,000-50,000 eggs, depending on her size.

## Redear sunfish

Redear sunfish, sometimes called shellcrackers, are also good fish to stock in Tennessee ponds. They must be stocked with bluegill because their low reproduction rate will not provide an adequate amount of forage (food) for bass, if stocked alone. Usually, some aquatic vegetation is needed for a successful redear sunfish population. They spawn in May-June and lay 15,000-30,000 eggs. Redear sunfish are nicknamed shellcrackers because they feed heavily on snails. They also feed on zooplankton and insects. Most weigh quarter- to a half-pound and grow to between 4 and 11 inches long.

## Channel catfish

Channel catfish adapt well to ponds and small lakes. They eat fish, insects, worms, crayfish and some plants. Channel catfish growth is highly variable, but under favorable conditions will grow more than a pound per year.

They usually reach spawning maturity at about 3 years old and typically spawn in late May through July when water temperature is 72-85° F. They rarely reproduce in ponds without the addition of spawning structures, but when they do reproduce, they lay from 2,000-70,000 eggs per year, depending on their size. Ponds rarely become overcrowded with channel catfish when largemouth bass are present because the bass usually eat enough of them to prevent them from becoming overcrowded.

Catfish do not have to be stocked in ponds with largemouth bass and bluegill/redear sunfish to maintain pond balance. See *Catfish-only fishing ponds* (41). However, if pond owners choose to stock channel catfish in combination with largemouth bass and bluegill/redear, they can be stocked in the fall at a rate of 50-75 per surface acre. When stocking channel catfish into an existing bass population, they should be at least 8-10 inches long so they will not be eaten by bass. Catfish are available from commercial fish sources.

## Triploid grass carp (White Amur)

Pond owners with nuisance aquatic weeds may want to stock triploid (sterile) grass carp to help control the problem. Aquatic plant control is slower with grass carp than with chemicals, but can be more cost effective in the long run. As a general rule they provide effective control for 5-7 years. See *Biological control* (16).

To be legal in Tennessee, grass carp sold and stocked into private lakes and ponds must be triploid (sterile). No special permit is required to stock grass carp at this time, but pond owners should obtain verification from the seller that they are purchasing triploid (sterile) grass carp.

Bluegill



Duane Raver, USFWS

Redear sunfish

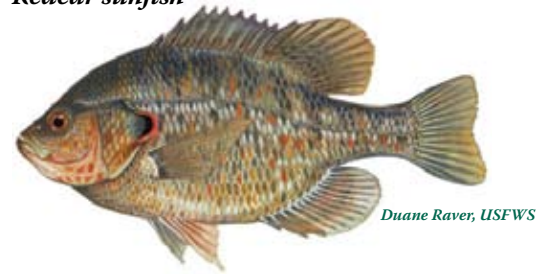

Duane Raver, USFWS

Channel catfish



Duane Raver, USFWS



Grass carp

USFWS

TWRA does not supply catfish or triploid grass carp for stocking into private ponds. These are available from commercial fish producers.

### ***Fish you should NOT stock***

Several species of game and forage fish that are popular in Tennessee reservoirs are not suitable in the controlled environments of small fishing ponds or lakes. For small fishing ponds and lakes, TWRA recommends ONLY the combinations of hatchery fish discussed on the previous pages. Any other combinations of fish could cause a pond to become unbalanced and make it necessary to eliminate the fish population before proper balance could again be established.

Black and white crappie should not be stocked into ponds smaller than 50 acres because they will spawn before bass, they will eat the small fish that young bass need to grow and they will eat young bass. The end result is usually a pond that is overcrowded with small crappie. If and when reliable sterile crappie are available, this could change but research continues.

Another species that should not be stocked into fishing ponds is gizzard shad, except under special management considerations. Shad eat zooplankton almost exclusively, which depletes the supply needed by bluegill and young bass. This reduces bluegill growth and reproduction, and survival of young bass. These ponds may also become overpopulated with shad of a size that only the largest bass can eat. Similarly, golden shiners and green sunfish should not be stocked into ponds because they cause the same kind of problems as gizzard shad.

Bullheads (yellow and black), also called mudcats or polywogs, should not be stocked into ponds because they compete with bluegill and channel catfish for food, and they can make the water muddy when feeding. This reduces the feeding capability of sight-feeding largemouth bass and bluegill. Muddied water can also reduce the production of planktonic algae and zooplankton, which are basics in the food web of fish. Bullheads also reproduce and become overpopulated rapidly, which results in large quantities of small fish that seldom become large enough to harvest.

Ponds with healthy bass populations seldom have problems with unwanted species.



*Duane Raver, USFWS*

***White crappie***



*Duane Raver, USFWS*

***Black crappie***

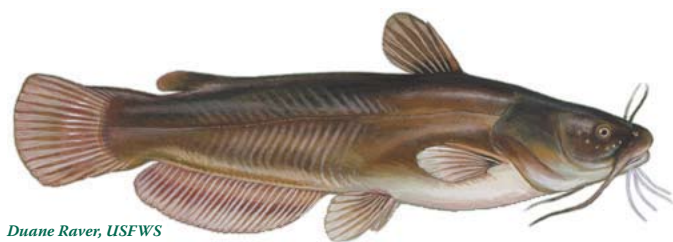

*Duane Raver, USFWS*

***Yellow bullhead***



*Duane Raver, USFWS*

***Black bullhead***



*Duane Raver, USFWS*

***Shad***



*Duane Raver, USFWS*

***Golden shiner***



# FERTILIZING YOUR POND

Proper alkalinity of the pond water is important for fertilizer to work properly in producing a phytoplankton "bloom." See *Liming* (13).

You must accurately determine the surface acreage of your pond before applying fertilizer. See *Pond measurement* (42-43).

There can be a greater risk of oxygen levels becoming too low and causing a fish kill in fertilized ponds. See *Dissolved oxygen* (28).

Fertilization is not recommended for everyone, as some ponds should not be fertilized. See page 12.

## Aquatic food web

Fertilizing pond water provides nutrients that increase the amount of food available for fish. This, in turn, increases the amount of fish a pond can support. Fertilizing a pond increases its phytoplankton, which are microscopic plants that give water a greenish color or "bloom." These phytoplankton are eaten by zooplankton (microscopic animals), which are, in turn, eaten by small crustaceans, insects and other aquatic organisms. These insects and other, larger organisms are then eaten by bluegill and small bass, which are then eaten by larger bass. The amount of phytoplankton in a pond, therefore, determines the amount of food available to every organism in the food web, and ultimately the number of pounds of fish the pond can produce and support. Although fertilization can increase productivity, it takes time and money, and has to be done correctly.

## Fertilizing to produce more fish

Fertilized ponds have a higher **carrying capacity** and can produce up to 400 pounds of fish per surface acre per year. Adequately fertilized ponds have a light greenish color caused by the phytoplankton bloom. With no existing aquatic weeds or algae present, this greenish color can discourage unwanted aquatic weed growth by shading the bottom where many weeds problems begin. Fish are also less likely to be frightened away by anglers than in unfertile, clear ponds.

Unfertile ponds, which are usually clear because of a reduced amount of phytoplankton, have a much lower carrying capacity. They rarely produce more than 100 pounds of fish per surface acre per year. Unfertile ponds are also more likely to have problems with aquatic plants, which can be expensive and time consuming to correct. See *Aquatic weed control* (14).

Small ponds that are adequately fertilized can produce more fish than unfertilized ponds that are much larger. The carrying capacity for fish increases to 2-4 times as much when a pond is properly fertilized, so fish must be harvested much more frequently and in greater amounts from fertilized ponds. Pond owners should be aware that there is a greater chance of oxygen levels becoming too low for fish in fertilized ponds, especially during hot, cloudy weather. See *Dissolved oxygen* (28).

## Types of fertilizer

Pond fertilizers are available in granular, liquid and powdered forms and are usually available at farmers cooperatives, feed stores and general farm supply stores. Any of these can be used in Tennessee ponds to produce a phytoplankton bloom. However, liquid and water soluble powder fertilizers are the easiest to apply, and dissolve more readily in the water thus requiring less time to establish the bloom. See Table 1 on page 11 for general fertilization rates. To determine the surface acreage of your pond, see *Pond measurement* (42-43).

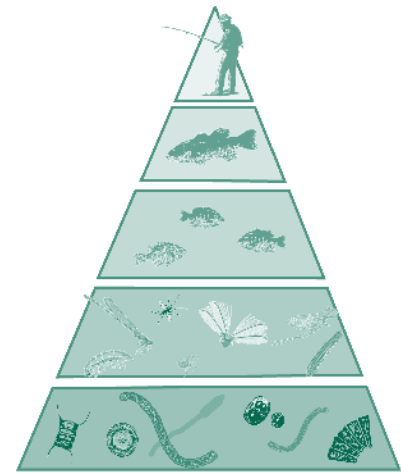

*Aquatic food web*

---

***Carrying capacity of a pond refers to the maximum weight (in pounds) of fish that a pond will support during a set period of time.***

---

Watch for early signs of possible fish kills caused by low oxygen levels such as fish gulping for air at the surface of the water in the early morning.

*Water in a fertilized pond with a healthy, phytoplankton bloom will be light green as shown below.*



Photos by Bobby Wilson

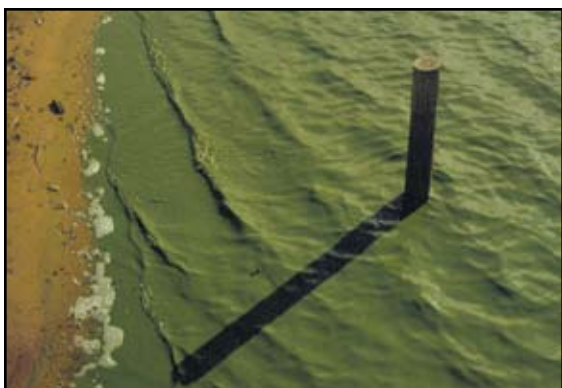

*This photograph shows excessive planktonic algae, which give water a "pea soup" green or brownish color. Ponds should not be fertilized when excessive or nuisance algae are present. See When not to fertilize (12).*

**Do not pour undiluted, liquid fertilizer directly into the water. It will sink to the bottom and become unusable.**

### **Granular fertilizer**

A good method for applying granular, including some time-released fertilizers is the use of platforms. Fertilizer platforms can be installed to distribute fertilizer more easily and efficiently by wind and wave action. A 3x3-foot platform is adequate for each 4-5 surface acres of water. Platforms should have solid bottoms (no cracks) and should be at least 10-15 inches below the water surface. (See illustration on next page.) Platforms should be placed in the end of the pond opposite the drain pipe, 8 to 12 feet away from the shoreline. The required amount of fertilizer can then be poured out onto a platform or the entire bag, cut open from top to bottom, can be laid on the platform.

If platforms are not used, the recommended amount of granular fertilizer should be left in the bag and laid along the shoreline so at least four inches of water covers it. Placing the bag on a tarpaulin or plastic sheeting will reduce the possible contact of the fertilizer and soil. Granular fertilizers that lay directly on the bottom become tied up in the soil, and become unavailable for phytoplankton. Fertilizer placed directly on the pond bottom can also encourage aquatic weed growth. Bags placed along the shoreline should be cut open from top to bottom. Wave action will dissolve the fertilizer and distribute it throughout the pond. Some pond fertilizers can be purchased that come in a floating container that is placed in the pond.

A time-released fertilizer that can be applied once a year (instead of the 6-8 times a year required with most other fertilizers) is available. The granular, pelleted formula such as 10-50-0 (nitrogen-phosphate-potassium) should be applied in the spring at a rate of 25-40 pounds per surface acre. When using ready-to-use, time-released fertilizer products in floating containers (or buckets), be sure to follow directions for adding the correct number of containers. The fertilizer is slowly released from spring through fall, although seasonal variations in climate (sunlight, rainfall) can compromise the effectiveness of the application. Pond owners should visit the pond occasionally to check the water visibility. If the pond is excessively green (visibility below 12 inches) the fertilizer bag(s) or container(s) should be temporarily removed.

### **Fertilizing with phosphate alone**

Some ponds, especially those that have been fertilized regularly with nitrogen-phosphate-potassium (N-P-K) fertilizer for 2-3 years, respond well to phosphate fertilization alone. Each application of phosphate fertilizer should consist of one of the following: 40 pounds superphosphate (0-20-0) per surface acre or 18 pounds of triple superphosphate (0-46-0) per surface acre. If a good phytoplankton bloom (greenish water) cannot be produced and maintained with phosphate alone, the pond owner should resume a regular fertilization program with a granular, liquid or powdered (N-P-K) formula.

### **Liquid fertilizer**

Because liquid fertilizer is heavier than water, it should always be mixed with water (normally one part fertilizer to five parts water) before applying. Liquid fertilizer will produce a phytoplankton bloom more quickly than granular fertilizer because it immediately dissolves in pond water. Use of liquid fertilizer is preferred in larger ponds and lakes over granular fertilizer because of its ease of use. Fertilization rates are listed in Table 1 on the next page.

Applying diluted liquid fertilizer is best done by boat in larger ponds. As you move across the ponds surface the diluted fertilizer can be poured into the prop-wash of the outboard motor, or sprayed over the surface. In smaller ponds, the diluted fertilizer can be sprayed from the bank as evenly as possible with a hand-held or power sprayer. Do not use a petroleum based liquid fertilizer.

### **Powdered fertilizer**

Powdered fertilizers, which are water soluble, are effective and easy to use. Formulas, such as 12-49-6 or 10-52-0, are typically applied at a rate of 2-8 pounds per surface acre, but follow label directions. Powdered fertilizers can be broadcast from the bank or boat without mixing with water first. Being water soluble, powdered fertilizers do not sink to the bottom and become tied up in the soil.

**Table 1.**  
*General fertilization rates for ponds*

Fertilizer Type	Formulation* (N - P - K)	Application Rate**
Granular	20-20-5	40 pounds per surface acre
	15-15-15	50 pounds per surface acre
	18-46-0	18 pounds per surface acre
Time released	10-50-0	25 to 40 pounds per surface acre
Liquid	10-34-0	1 gallon per surface acre***
	11-37-0	1 gallon per surface acre***
	13-38-0	1 gallon per surface acre***
Powdered	12-49-6	2 to 8 pounds per surface acre
	10-52-0	2 to 8 pounds per surface acre

\* These are just some of the more common formulations that are available.

\*\* These are general fertilization rates. Follow rates and application methods on product label.

\*\*\* These should be diluted with at least 5 gallons of water, then applied evenly in the pond. Follow instructions on label.

### When to fertilize

Before beginning a fertilization program, it is advisable to measure the pH and alkalinity of the water, since ponds with low pH (below 6.0) and low alkalinity (below 20 milligrams per liter) will usually not respond to fertilization, and needs to be limed first. See Liming (13). Fertilization with liquid, granular or powdered fertilizer should begin in the early spring (usually early April) when the water temperature stabilizes above 60° F. General fertilization rates are shown in Table 1, above. Unless using a time-released fertilizer that only needs to be applied once a year, fertilizer will usually need to be applied 6-8 times per year. So, enough fertilizer should be purchased in the spring to last the entire season. Fertilization should be discontinued in the fall (usually late September or early October) when the water temperature falls below 60° F. For advice about fertilizing your pond, contact your regional TWRA biologist or UT Agricultural Extension Agent. See *Seeking assistance* (44-45).

The second application of fertilizer should be made from 10-14 days after the first application. This usually establishes the phytoplankton bloom that should be maintained throughout the summer. Generally, once the bloom has been established, fertilizer should only be reapplied when it is possible to see more than 18 inches into the water. On the average, this occurs once every 30-45 days. Therefore, ponds should be fertilized based on water visibility rather than a regular time interval. If a bloom is not established after the second application of the recommended fertilizer, alkalinity may be low. See *Liming* (13).

A good way to tell if you can see 18 inches into the water is to attach a white or shiny object such as a pie pan to the end of a stick. Then put a mark on the stick 18 inches up from the white or shiny object. If the object on the end of the stick can be seen clearly when submerged into the pond to the 18-inch mark, another application of fertilizer is needed. Another good method is if you can clearly see your fingers when your arm is under water at elbow depth, visibility is approximately 18-20 inches.

Some ponds require more frequent fertilization than others to maintain a good phytoplankton bloom. A record of the date and amount of fertilizer used should be kept. With proper record keeping, adjustments in the amount of fertilizer needed for best results can be made easily.

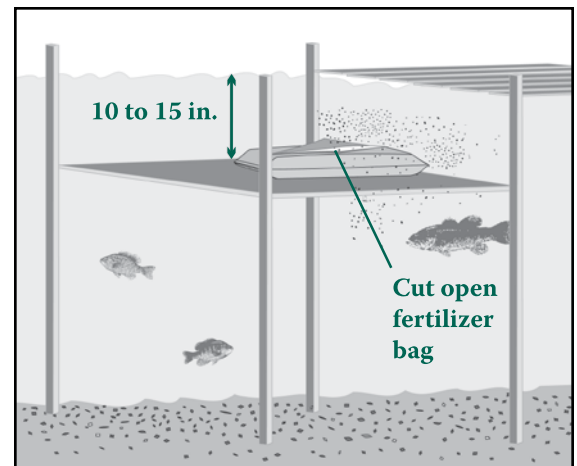

**Fertilization platform connected to a fishing pier**



## When NOT to fertilize

Successful fertilization requires regular applications, except for time-released formulas, and discontinuing it once started can leave you worse off than if you had never started it. If the pond owner is not willing to apply fertilizer at necessary intervals and continue fertilization efforts annually, all benefits of fertilization will be wasted, and fish populations may become unbalanced. Fish become dependent on the extra food produced as a result of fertilization. Stopping fertilization reduces available food for fish, and their growth slows or stops. Also, if fertilization is begun, then stopped, nuisance aquatic plants are likely to emerge and become a nuisance.

Some ponds should not be fertilized. Do not fertilize in the following cases:



Photo by Dave Rizzuto

- 1. Nuisance algae or aquatic weeds are present** – Unwanted aquatic weeds and algae must be controlled before fertilizer is applied, since fertilizer will promote the weed growth and compound the problem. Nuisance plants and algae are not only unattractive, they can use up nutrients that would otherwise be used by beneficial phytoplankton, and they can lead to oxygen depletion and fish die offs. They can also be a nuisance when they get caught on hooks and lures. See *Dissolved oxygen* (28). In Tennessee, excessive planktonic algae, which give water a “pea soup” green or brownish appearance, are common (see photograph on page 10). Filamentous algae, also known as pond scum, moss or slime, is also common in Tennessee (see photograph on inside back cover). For information about how to control nuisance algae and aquatic weeds, see *Aquatic weed control* (14).
- 2. Fish population is not in balance** – Fertilization will not improve fishing in unbalanced ponds. Balance refers to the number and weight of predatory fish (bass) compared to the number and weight of forage fish (bluegill and sunfish) in the pond. See *Fish population balance* (20). In ponds that are already overcrowded, fertilizing will produce more pounds of fish, but the average size of the fish will usually be very small. The balance of the fish population in older ponds should be determined before fertilization is begun. If a pond is overcrowded with bluegill or sunfish, fertilization should not be started. Thinning the bluegill population may be necessary to correct this situation and should be done in the fall. See *Avoiding overcrowding* (20).
- 3. Pond is usually muddy** – If the water is muddy or becomes muddy after rains, do not fertilize until the water clears or the problem is corrected. See *Muddy water* (35).
- 4. Pond is not fished often** – Ponds that are not fished often do not need fertilizer. Fish must be harvested (removed) frequently and in greater amounts from fertilized ponds.
- 5. Pond is in well managed pasture with livestock** – Ponds in well managed pastures with high numbers of livestock usually do not need fertilization. This is especially true where livestock has direct access to the pond and deposits animal waste, and therefore nutrients, directly into the pond.
- 6. Fish are being fed** – Pond owners who feed fish may not need to fertilize because the nutrients in uneaten fish feed may produce the desired phytoplankton bloom.
- 7. Pond has high flow rates** – Excessive or continuous water flow through the pond washes out the fertilizer, therefore, at least 30 to 40 days of water retention (without extremely heavy rain) is necessary for fertilization to be effective.
- 8. Pond is naturally fertile** – Some ponds are naturally fertile because of high soil fertility where the pond is built, or because of the amount and kind of nutrients added by runoff from the watershed. If the transparency of the pond’s water is less than 18 inches deep during the summer, do not add fertilizer.

While not all ponds need to be limed, some do not develop a satisfactory “phytoplankton bloom” when fertilized at recommended rates because of low water alkalinity and soil pH. Ponds with total alkalinity below 20 parts per million (ppm) are sometimes acidic with pH levels below 6.0, and this keeps the phosphorus added as pond fertilizer from becoming available to provide nutrients for the bloom. The recommended range of total alkalinity for fish ponds is 20-200 ppm, and do not need liming. Note that algicides containing copper compounds, when used to treat nuisance algae in fish ponds, may not be effective and can kill fish when total alkalinity is out of range (see page 16).

Adding lime (calcium carbonate) will increase water alkalinity and in turn raise the pH level of the water, while at the same time act as a buffer in controlling high daily pH fluctuations. The pH of well buffered water should fluctuate between 6.5 in the morning to 9.0 in the afternoon.

### **Water testing in existing ponds**

Water in existing ponds can be tested for total alkalinity and pH using a water testing kit available from swimming pool supply stores, and many hardware stores. Note that some test kits measure alkalinity in parts per million (ppm) and some in milligrams per liter (mg/l), but they are equal measurements. Ponds with water having less than 20 ppm total alkalinity usually need lime. Testing should be conducted early in the morning.

### **Soil testing for liming rates**

Even though the water testing will indicate if lime is needed, it does not tell how much. A soil sample taken from the pond bottom can be analyzed by the UT Extension Service Soil Testing Lab in Nashville (see page 45). A minimal fee is charged for the analysis. For existing ponds, use a boat to collect soil from 8-10 locations per acre throughout the pond using a can fastened to a pole. Mix the samples thoroughly, and allow it to dry. Then place a sample of the mixture in a shipping box available from your County Extension Office, label it as a pond sample, and mail it. The soil analysis you receive will indicate how much lime your pond needs. As a general rule, about one ton of agricultural lime per acre is required to raise pH one point.

New ponds are easiest to lime before they are filled with water. Before filling, collect a soil sample for analysis following the procedure described above.

### **How and when to lime**

The best liming material is granular agricultural or dolomitic limestone. This is the same type of lime that farmers use on their crops, and can be purchased in bulk or bag form. Hydrated lime, quicklime or builder’s lime are generally not recommended, as they are caustic and has the potential to increase pH too quickly, and kill fish.

Time is required for lime to react with bottom mud and provide the beneficial results; therefore the best time to apply lime is the late fall or early winter.

For new ponds, the required amount of lime can be spread evenly over the bottom using a lime spreader truck and then disked in. The required amount of lime can also be bought in bags and spread evenly over the pond bottom.

For existing ponds the required amount of lime should be spread evenly over the entire pond surface. A common method for applying the lime is to shovel it or wash it from a plywood platform built on a boat as you move around the pond. On small ponds that have adequate vehicular access around the shoreline a lime spreader truck can be used to spread the required amount to lime. Liquid lime, available from some aquaculture supply stores, can ease application but may not last as long as a granular limestone application.

A granular lime treatment will usually last from 2 to 4 years depending on the amount of water that flows through the pond, and the acidity of the bottom mud.

Algicides containing copper compounds can kill fish in ponds with low alkalinity.



*Photo by Doug Markham*

Lime should not be added in the summer because the phosphate in fertilizer separates out in warmer temperatures and is unavailable to phytoplankton as a nutrient.

# AQUATIC WEED CONTROL

Aquatic herbicides or algicides should not be applied to a pond or lake that has water continuously flowing from it.

Treating nuisance aquatic weeds, especially during the hot summer months, can be risky.

DO NOT fertilize a pond that has nuisance aquatic weeds and algae present.

---

***Pond balance refers to the ratio and weight of predatory (bass) and forage fish (bluegill/red-ear sunfish) in the pond.***

---

Although aquatic plants can provide many benefits to fish, they often become a nuisance by interfering with fishing, swimming, and boating. Once an aquatic plant becomes a nuisance, it should be controlled. While up to 20 percent of a pond could have appropriate aquatic plants such as pickerelweed and select water lilies, it is generally better to keep your pond clear of aquatic plants. Be careful about buying aquatic plants found at some nurseries or backyard pond supply stores. Some of these plants may be exotic and become a nuisance in a recreational fishing pond.

Excessive nuisance aquatic weeds and filamentous algae must be controlled for a fishing pond or lake to maintain a proper **balance**. Too many aquatic weeds and algae compete with desirable phytoplankton for nutrients, and results in a more limited quality of fish being produced in the pond. A more serious problem caused by an overabundance of aquatic weeds and algae is the excessive cover they provide for small fish. Fish populations often become unbalanced when too much aquatic vegetation protects the small bluegill from the bass. Ponds with excessive aquatic weeds and algae growth usually have large numbers of small fish, and the fishing is usually poor.

## ***Avoiding aquatic weed growth***

The best way to prevent unwanted aquatic weed growth is constructing a pond in the proper location with the proper pond and shoreline depth. See *Pond depth, bank slope and shoreline depth* (2.) However, in an established pond, preventing submersed aquatic plant growth is the most practical solution. This can be done by deepening any shallow water areas less than two feet deep, reducing any nutrient runoff, and in some cases, starting a regular fertilization program only after plant growth is eliminated. Once the fertilizer produces a desirable phytoplankton "bloom" (light greenish water), this will shade out some sunlight and suppress aquatic plant growth. See *Fertilizing your pond* (9-12). Anytime sunlight can penetrate to the pond bottom, rooted aquatic weeds and filamentous algae may become established. Dyes, discussed on the next page, are also available to provide the shading effect. Also, problems with aquatic weeds, particularly algae and floating weeds such as duckweed and watermeal usually develop in ponds that receive excessive nutrient-rich runoff from livestock operations, fertilized lawns and watersheds. This runoff must be reduced or eliminated before any long-term control of the weed problem can be obtained.

## ***Identifying aquatic plants***

A first step in controlling aquatic plant growth is identifying the plants that need to be removed so you can select the most effective and economical herbicide and/or method. For assistance in identifying nuisance plants, pond owners should contact a TWRA biologist or UT Agricultural Extension Agent. See *Seeking assistance* (44-45). If a biologist cannot visit on-site, the pond owner may bring or mail a sample of the plant to the nearest TWRA biologist for identification and treatment recommendation.

There are generally three types of aquatic plants found throughout Tennessee; emergent, submersed and floating. Emergent plants grow out of the water. Examples of emergent plants that commonly become nuisances in Tennessee are water primrose, cattail and willow. Submersed plants grow under the water and include pondweeds and Southern naiad. Floating plants, of course, float on the surface. Duckweed and watermeal are good examples of floating nuisance plants. Filamentous algae, floating or submersed, is also very common. See the inside back cover for photographs of these common aquatic plants found in Tennessee.

Once aquatic plants or algae become a problem, they can be controlled through mechanical, chemical and biological methods as discussed in the following sections.

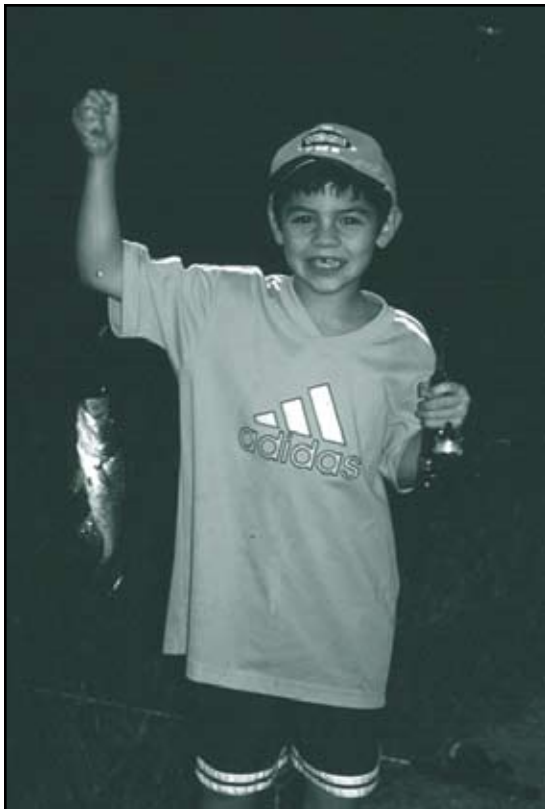

Photo by Bobby Wilson



## Mechanical Control

This method consists of removing plants by pulling, raking, cutting, and digging. This method is probably the least expensive but the most labor intensive, and is best used in limited areas during the spring or early summer while the plants are small and before they produce seeds. Tools specifically made for aquatic plant removal are commercially available. When removing plants by hand or tools, it's important to remove as much of the plant fragments as possible, as many of them can reproduce from fragments. Mechanical control also consists of dragging a chain or cable through the vegetation, and shading, which is done by placing a large piece of black plastic or screening over the vegetation at the surface for a period of 2-4 weeks. Only a section of the pond should be covered at any one time, and the plastic/screening will need to be tied off or anchored to keep it in place.

Winter drawdowns are another effective method of vegetation control if the pond has a drain pipe that will allow the water level to be lowered one-third to one-half, beginning in late November, and kept down through February. This exposes the weeds to drying and freezing. Spring rains will fill the pond, and any weeds that persist or sprout can be treated with an appropriate herbicide. Winter drawdowns can also be useful as a fish population control method as discussed on page 25.

## Chemical control

Only a few chemicals and herbicides are presently approved for use in recreational fishing ponds. See Table 2 on page 19. The U.S. Environmental Protection Agency (EPA) and the U.S. Food and Drug Administration (FDA) rigidly control use of these chemicals and other herbicides that are capable of controlling aquatic plants in ponds containing fish and other aquatic life. Because of this, aquatic herbicides are safe to use when used according to the label, including rates and guidelines for use. The label will tell how much to use per surface area of vegetation or per volume of water to be treated, so you will need to know the surface area and/or volume of water in the pond. See *Pond measurement* (42-43).

Be aware that chemical control will normally need to be repeated since weeds will frequently return if action is not taken to eliminate the conditions for growth, such as deepening shallow areas and controlling nutrient-rich runoff. As mentioned earlier, proper identification of the aquatic plant is necessary in order to select the proper herbicide.

Floating aquatic plants such as duckweed and watermeal have been controlled using Diquat, 2,4-D and Fluridone depending on the species. A nonionic surfactant that is approved for aquatic use is usually added to the herbicide before spraying. A surfactant, available where aquatic herbicides are bought, is a soapy substance that helps the herbicide stick to the plants. Watermeal is more difficult to control, and at this time Fluridone is recommended for long-term control. Watermeal, which floats on the surface is very small, bright green in color and feels like tiny grains of sand when rubbed between the thumb and fingers (see photographs on inside back cover).

For control of emergent plants such as water primrose, cattail and willow, chemicals such as Glyphosate, 2,4-D and Triclopyr can be used effectively depending on the plant species. Results are often improved when a nonionic surfactant is used (see photographs on inside back cover).

For control of submersed plants such as pondweeds and Southern naiad, chemicals such as Chelated Copper, Diquat, Endothall, Fluridone, or Dyes can be used effectively depending on the plant species. Normally, the use of surfactants are not recommended for submersed weed control treatments, but be sure to read and follow label directions.

## Dyes

Another chemical control method that can be used to control submersed aquatic vegetation is a non-toxic pond dye. Dyes turn the water a bluish color and help control weeds by shading (blocking sunlight) the pond bottom so plants can't get established. Dyes can be used throughout the year, and are suited for ponds with little outflow and that are not fertilized. Be aware that pond productivity will be reduced when using dyes because the shading it provides blocks the phytoplankton bloom. However, for those that do not plan to fish their pond heavily or fertilize, dyes can be a proper choice.

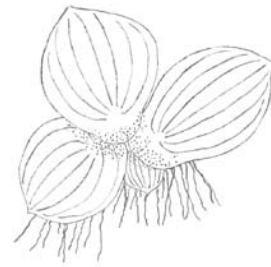

**Duckweed**  
(See photographs on inside back cover.)



**Watermeal**



**Pondweed**



**Southern naiads**

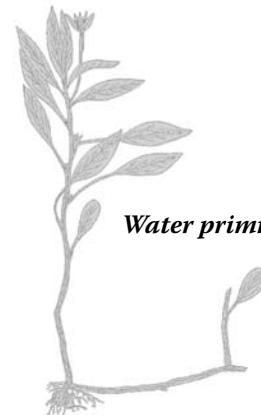

**Water primrose**



**Cattail**

Algicides containing copper compounds can kill fish in ponds with low alkalinity.

Aquatic herbicides and algicides should not be used in bodies of water that flow constantly into streams, or other ponds or lakes.

Users of aquatic herbicides or algicides are always responsible for their effects if they drift or move to private or public property.

Chemicals must always be handled according to the instructions provided on labels, and manufacturer's instructions should be strictly followed when preparing, applying, storing and disposing of chemicals .

Only those herbicides approved by the EPA for aquatic use can legally be used in ponds and must be used according to label directions.

### **Chemical control of nuisance algae**

There are three main types of algae that become a nuisance in excessive amounts. They are planktonic, filamentous and attached algae. These should not be confused with desirable phytoplankton blooms that give water a light greenish color, and are desirable for a pond to be more productive for fishing.

The most common nuisance algae found in Tennessee ponds and lakes are filamentous algae. Filamentous algae, often called pond scum, pond slime or moss, usually begin growing along the edges or bottom of the pond. Then, because of a buildup of oxygen in the plant, filamentous algae, which can be slimy, cottony or coarse, floats to the surface (see photograph of filamentous algae on inside back cover). Excessive planktonic algae, including blue-green algae, in a pond can give water a "pea soup" green or a brownish appearance instead of the desired, light-green color produced by a healthy phytoplankton bloom (see photographs of a healthy phytoplankton bloom and excessive planktonic algae on page 10). The attached forms of branched algae, such as Chara (muskgrass) and Nitella (stonewort), grow from the pond bottom and are best identified by their musky odor, or gritty, bristly feel. Dense growths of this algal type occur primarily in clear water.

Most types of nuisance algae can be controlled with algicides (herbicides specifically formulated to kill algae). To select an algicide, it is helpful to know what type of algae needs to be controlled.

Copper compounds are the active ingredient in most algicides, however several non-copper algicides are now available. Before using copper based algicides, the alkalinity of the water in the pond should be determined, because some types of copper compounds, such as copper sulfate, or bluestone, applied at rates to control algae can be toxic to fish in waters with low total alkalinity (less than 40 milligrams per liter). In water with total alkalinity of more than 250 milligrams per liter, copper sulfate separates out and is not effective for algae control. The toxicity of copper sulfate to fish also increases as water temperature increases, so pond owners should avoid using copper sulfate during the hot summer months. Other types of copper compound algicides are called chelated copper complexes. These algicides do not readily separate out, however, they should not be used in waters with alkalinity below 40 milligrams per liter. The total alkalinity of the pond water can be determined by using a water test kit, which can be purchased at swimming pool supply stores, and many hardware stores.

### **Applying herbicides and algicides**

EPA approved aquatic herbicides or algicides, when used as directed on the label, are safe to use, and the chemicals themselves will not harm fish or other aquatic life. However, herbicides and/or algicides should be applied at the correct time to ensure effectiveness. In most cases it is best to apply herbicides/algicides in the spring and early summer after the water temperature has reached about 65° F. At this time of the year, most weeds have yet to produce seeds, and with fewer weeds being present, less herbicide will be required.

Treating nuisance aquatic weeds, especially during the hot summer months, can be risky. Aquatic plants that are killed by herbicides/algicides undergo decomposition. The decomposition process consumes oxygen and can reduce the amount of oxygen available for fish, especially during the hot summer months when oxygen demand is greater. Although the chemicals used to treat nuisance plants will not directly harm the fish, the low oxygen levels in the pond can kill them. See *Fish kills* (28-31). To reduce this risk, the pond owner should treat only between a quarter and a third of the pond at 7- to 10-day intervals. See *Dissolved oxygen* (28). Spot treatments may be necessary throughout the growing season.

Chemicals used to treat aquatic weeds and algae (Table 2, page 19) are available at farm cooperatives, farm supply stores and aquaculture supply companies. New chemicals are continually being developed, so pond owners are encouraged to contact TWRA or their UT Extension Agent for possible up-to-date information about aquatic herbicides and their usage. See *Seeking assistance* (44-45).

### **Biological control**

The grass carp (*Ctenopharyngodon idella*) is the primary fish used for the biological control of aquatic vegetation in the United States. Many aquatic weeds, particularly low-fiber submersed weeds, can be controlled with grass carp, also

*Chara*



*Nitella*



known as white amur. Native to Southeast Asia, the grass carp was first brought into the United States in the early 1960s as an experimental aquatic weed control method. Because of the potential impact that reproducing grass carp could have on the environment and native fish populations, research led to producing sterile “triploid” grass carp, eliminating the possibility they may reproduce if they escape into the wild. Aquatic weed control is slower with grass carp than with chemicals, but can be more cost effective in the long run. See Table 2 (page 19) for list of aquatic weeds that are consumed by grass carp.

Triploid grass carp will not spawn in ponds or small lakes, will not muddy the pond by rooting vegetation, and their diet is primarily aquatic vegetation. A 5-pound grass carp can consume as much as 2-3 times its weight daily, and can grow to over 50 pounds. However, consumption of aquatic plants will decrease as the fish grows. For example, by the time a grass carp reaches 15-20 pounds, its consumption rate will decrease to about 20-25 percent of body weight per day.

Generally, for ponds containing largemouth bass, grass carp for stocking should be 10-12 inches long to avoid being eaten by the bass. This is the size of fish that is generally available from commercial hatcheries. Ponds in their first year of being stocked with hatchery fish can use smaller grass carp. For ponds with slight aquatic vegetation coverage (15-25 percent of the pond), up to five grass carp per surface acre are recommended. Ponds or small lakes with moderate vegetation coverage (30-45 percent of the pond) should be stocked with 5-10 grass carp per surface acre. For ponds with excessive aquatic vegetation coverage (greater than 50 percent of the pond), 15-20 grass carp per surface acre should be stocked. To avoid eliminating all the aquatic vegetation in a short period of time, thereby subjecting grass carp to starvation, it’s recommended to initially stock at the lower range of the above stocking rates.

Since grass carp will follow flowing water, care should be taken to prevent the escape of grass carp from the pond through the spillways and/or overflows. This can be accomplished by constructing a barrier across the spillway or overflow pipe. The openings in the barrier should be small enough to keep grass carp from escaping, but large enough to let debris such as leaves pass through. It’s important to check the barrier and remove debris regularly. Considerable thought should be given to installing barriers. A barrier that becomes clogged with debris could cause water to flow over the dam or levee causing damage, and even pond failure. If the possible escape of grass carp is a concern, and it’s not practical to install barriers, then a minimal number of carp should be stocked and/or other methods used.

Time is required for grass carp to control aquatic weeds and the results are not usually obvious until their second year in the pond, depending upon the amount and type of plant infestation and stocking rates. As with other fish, grass carp are more active in warmer water temperatures. In cases where there is excessive aquatic vegetation, the pond owner may treat the vegetation with an herbicide first, and then stock a reduced number of grass carp. Approximately 5-7 years after initially stocking grass carp, restocking may become necessary to continue the desired level of control because grass carp are less effective in controlling aquatic vegetation as they grow larger, and some will die of natural causes.

It should be noted that grass carp will consume floating fish food. In ponds where supplemental feeding of bluegill and catfish occurs, you may want to consider other aquatic weed control options, since feeding the grass carp will reduce their appetite for aquatic weeds.

To be legal in Tennessee, grass carp sold and stocked into private lakes and ponds must be triploid (sterile). No special permit is required to stock grass carp at this time, but pond owners should obtain verification from the seller that they are purchasing triploid grass carp. Grass carp may be purchased from a commercial fish producer, many of which visit local farm and feed supply stores in each county. Further information about purchasing grass carp from commercial sources can be obtained by contacting TWRA or your UT Extension Office. See *Seeking Assistance* (44-45).

Tilapia, a non-native tropical fish will consume watermeal and filamentous algae, but being a warm water species, will not survive in water temperatures below 52° F. Therefore, tilapia usually cannot be stocked before April and will die in November or December. Recommended stocking rates are 15-20 pounds of tilapia per acre



**Grass carp**

*Photo by Bobby Wilson*

**Only triploid (sterile) grass carp are legal to stock into private waters in Tennessee.**



after the water reaches at least 60-65° F, and before watermeal or algae becomes excessive. The three tilapia species legal to stock into private ponds and lakes are the Blue tilapia (*Oreochromis aureus*), Nile tilapia (*Oreochromis niloticus*), and the Mozambique tilapia (*Oreochromis mossambicus*). Tilapia should be at least three inches long, particularly when largemouth bass are present. This size fish will reproduce and provide more consumers, but still may not give satisfactory control if the pond has a robust bass population. Tilapia are good to eat and can be harvested by fishing or netting in the late fall as the water temperature falls below 60° F.

No special permit is required at this time to stock the above tilapia species, but they are usually not available everywhere across the state. Currently, only a few commercial fish suppliers sell tilapia. Further information on purchasing tilapia from commercial sources can be obtained by contacting TWRA or your UT Extension Office. See *Seeking Assistance* (44-45).

### **Barley Straw**

The use of barley straw to control algae has recently received attention based on research done in the U.K. that showed that barley straw prohibits the growth of many types of algae, but not all. The research found that barley straw controls algae through a complicated chemical reaction involving decomposition of the straw that is poorly understood, and this chemical reaction does not eliminate existing algae, but prevents the growth of new algae.

Limited research studies in the U.S. have shown mixed results, and that barley straw does not always solve algae problems. Reports from pond and lake owners who have tried barley straw have ranged from success to failure. Also, barley straw has not gone through the testing required for registration by the U.S. Environmental Protection Agency, so it can't legally be sold as a pesticide to control algae. However, landowners may apply it to their private pond or lake as a "home remedy," with the understanding that it may not work as expected. There are ready-to-use barley products available from some farm and pond supply stores.

Should you decide to try barley straw as an algae control technique, following are some general guidelines:

- Use of barley straw is not recommended if you are fertilizing your pond.
- Dried barley straw should be used, not barley hay or fresh barley.
- Since barley straw seems to prevent new algae growth, with little effect on existing algae already present, the placement of the straw should be done early (early April) before algae growth starts.
- Do not expect immediate results as the algae control properties of barley straw begins after the straw begins to decompose, and this depends on the water temperature. When the water temperature is below 50° F, it generally takes 6-8 weeks for the straw to become effective. At water temperatures of 70° F or above, it only takes 1-2 weeks to become effective. The activity of the straw last about 4-6 months, and then the control properties will be gone.
- While the risk is small, the decomposition of the straw requires oxygen, which could lead to a fish kill in some ponds. The pond owner may wish to install an aerator to reduce this risk.
- The amount to apply for ponds with a history of algae problems is 200-275 pounds of barley straw per acre (about 4-6 bales). This rate is equivalent to about 0.7-1.0 ounce(s) per 10 square feet, respectively.
- If actual bales of barley are used, the bales or loose barley should not be just thrown into the water. The bales must be broken apart and the barley straw loosely placed in some type of netting or woven bag or sack so that water and air can circulate through the straw. The amount of netting or bags required will depend on the their capacity. For example a 50-lb.capacity onion or potato bag will hold about seven to ten pounds of straw. A float should also be place within the netting/bags to keep them near the surface of the pond. Water movement at the surface will keep the straw well oxygenated and promote decomposition. Increasing aeration in the pond, by the use of an aerator, may help decomposition which may improve control activity. See *Aeration* (29). Barley straw that is already bagged is available from some farm and pond supply stores.
- The bags (or several bags tied together) should be placed evenly around the pond in water no deeper than 5 feet, and anchored or tied in place.

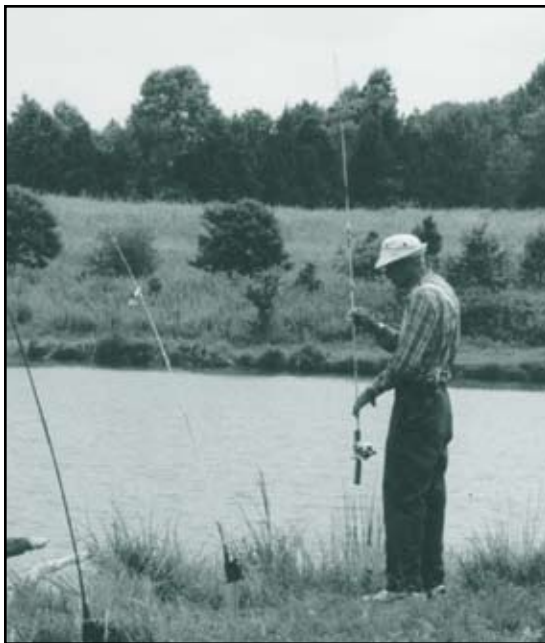

Photo by Dave Rizzuto

Aquatic Group	Weed	Tilapia <sup>1</sup>	Grass Carp	Copper and Chelated Copper Complexes <sup>2</sup>	Chelated Copper Herbicides	Non-copper Algicide	2 - 4 - D	Diquat <sup>3</sup>	Endothall	Fluridone	Glyphosate	Triclopyr	Aquatic Dyes <sup>4</sup>	Barley Straw <sup>5</sup>
Algae	Planktonic Filamentous Chara	♦	♦ <sup>6</sup> ♦	♦ ♦ ♦		♦		♦	♦ <sup>4</sup> ♦ <sup>4</sup> ♦ <sup>4</sup>				♦ ♦	♦
Floating Weeds	Duckweed Watermeal Waterhyacinth	♦ ♦	♦ ♦ <sup>6</sup>		♦		♦ <sup>8</sup> ♦	♦ ♦		♦ <sup>8</sup> ♦ <sup>8</sup>		♦		
Submersed	Coontail Watermilfoil Naiads Elodea Pondweeds Hydrilla		♦ ♦ ♦ ♦ ♦ ♦		♦ ♦ ♦ ♦ ♦		♦ ♦	♦ ♦ ♦ ♦ ♦ ♦	♦ ♦ ♦ ♦ ♦ ♦	♦ ♦ ♦ ♦ ♦ ♦		♦	♦ ♦ ♦ ♦ ♦	
Emergent	American lotus Cattails Smartweeds Waterprimrose Waterlily Willows		*  * *				♦ ♦ ♦ ♦ ♦ ♦	♦		♦ ♦ ♦ ♦ ♦	♦ ♦ ♦ ♦ ♦	♦ ♦ ♦ ♦ ♦		

**Table 2. Biological and chemical control of common aquatic weeds**

Note: It is not intended that any suggested usage in this table be in violation with existing regulations or manufacturers label.

- 1 See page 17
- 2 Use products containing copper with caution because its toxicity to fish and its effectiveness in controlling aquatic weeds depends on the total alkalinity of the water.
- 3 Use in bright sunny weather. Do not use in muddy water.
- 4 Do not use where water is used for human consumption.
- 5 See page 18
- 6 Young fish
- 7 Hydrothol formulations only, but may be toxic to fish at application rates used for weed control.
- 8 Liquid formulations.

\* Grass carp are not likely to reduce mature stand of these plants, but may eat new sprouts and help prevent further expansion by these plants.

\*\* Many of these have water-use restrictions; read label.

\*\*\* Use of trade names or brand names is for clarity and information purposes only. It does not imply endorsement of the product to the exclusion of others that may be of similar, suitable composition. Nor does it guarantee or warrant the standard of the product.

Chemical**	Trade Names***
Copper & Chelated-Copper Complexes (L&G)	Copper Sulfate, Bluestone, Earthtec, Cutrine, K-Tea, Captain, Algimycin, Symmetry, others
Chelated Copper Herbicides (L)	Komeen, Harpoon, Current, Nautique
Non-copper Algicide (L&G)	GreenClean, Phycomycin, Pak 27
2-4-D (L&G)	Aquacide, Navigate, WeedRhap, others
Diquat (L)	Reward, Weedtrine-D, others
Endothall (L&G)	Aquathol, Hydrothol
Fluridone (L&G)	Sonar, Avast
Glyphosate (L)	Rodeo, AquaPro, Eagre, AquaStar, others
Triclopyr (L&G)	Renovate 3
Aquatic Dyes (L)	Aquashade, Aquashadow, Blue Lagoon, Admiral, Aquaveil, others

L=Liquid, G=Granular

# MANAGING FISH POPULATIONS

Fish must be harvested regularly for the population to remain in balance.

---

*Balance refers to the ratio and weight of predatory (bass) to forage fish (bluegill/redear sunfish) in the pond.*

---

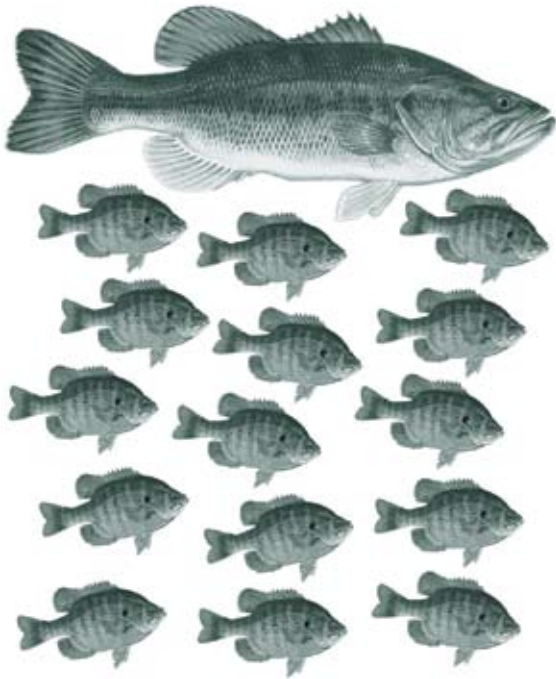

Bass overcrowding often occurs in catch-and-release only ponds because few or no bass are caught and kept.

This section explains how pond owners can achieve and maintain a balanced pond. Once a pond is properly built, the pond must be stocked at recommended rates. See *Pond construction* (1-4) and *Stocking* (5). To keep a pond in balance, a pond owner must properly maintain the pond's dam, spillway and surrounding vegetation, diligently control aquatic weeds and properly harvest fish. See *Aquatic weed control* (14-18) and *Pond production and fish harvest* (21). In managed ponds, sampling of the fish population should be routine, and for ponds that have been stocked for two years or more, keeping a record of fish caught, harvested (kept) and released is also important.

## **Fish population balance**

To understand stocking and maintaining a pond so the quality of fishing remains high, you must understand pond **balance**. Predatory fish (bass) primarily eat or prey on other fish. Forage fish (bluegill/redear sunfish) primarily eat insects and snails. To be in proper balance, there should be 3-5 pounds of bluegill/redear sunfish to every pound of bass. Maintaining quality fishing will require sensible harvesting by anglers, with most of the harvest being bluegill/redear sunfish. If a pond becomes seriously out of balance, completely eliminating the remaining fish population and restocking may be necessary.

## **Avoiding overcrowding**

The best way to avoid overcrowding in a pond is to harvest fish regularly and in adequate numbers (see Tables 4 and 5 on page 21). If the average size of bass or bluegill/redear sunfish is small, it is usually an indication of overcrowding, and the species that is small should be fished more heavily. The condition (plumpness) of the fish can be an indicator of population balance or imbalance. In bluegill-crowded ponds, bluegill will be abundant, small and/or skinny. In a seriously overcrowded pond, their eyes may be large and bulging. In bass-crowded ponds, bass will be abundant and will usually have small bodies and large heads.

When bluegill/redear sunfish are overcrowded, usually caused by too many bass being caught out, their reproduction slows or completely stops. Such a reduction in small forage fish seriously threatens pond balance because it limits the survival of young bass in the pond. Successful bass spawning is almost impossible in a bluegill/redear sunfish-crowded pond because the bluegill/redear sunfish eat bass eggs. Bluegill/redear sunfish also stop reproducing, so no forage is available for surviving bass fingerlings. Fishing exclusively for bass in a pond leads to bluegill overcrowding and results in a seriously out-of-balance fish population. Excessive removal of bass is a common cause of fishing quality becoming poor. Therefore, it is vital not only to stock fish at recommended rates, but to harvest (remove) fish species properly as well.

One solution to excessive removal of bass is for the pond owner to impose a minimum size limit of 12 or 14 inches, and unless they become overcrowded, limit the harvest of bass under 12 inches. This can provide excellent catch-and-release fishing and will maintain enough bass to help keep the bluegill under control. However, it is essential to harvest some bass, along with bluegill, throughout the fishing season (see Table 4 on the next page).



## Pond production and fish harvest

Most large ponds are underfished, and small ponds are frequently overfished to the point of becoming seriously unbalanced. To appropriately regulate pond harvest so balance can be maintained, pond owners should understand pond production potential, or **carrying capacity**.

The weight of bass and bluegill (or bluegill/redear sunfish) that can be produced in Tennessee ponds ranges from less than 100 pounds of fish per surface acre in unfertilized ponds up to 400 pounds of fish per surface acre in fertilized ponds. In a pond that supports 70 pounds of bass, there may be 70 1-pound bass, 140 ½-pound bass or any combination of sizes that total 70 pounds (see Table 3 below). As with stocking fish at the appropriate rates, it is important to know the surface acreage of your pond to harvest at appropriate rates. See *Pond measurement* (42-43).

For instance, as shown in Table 4 below, approximately 12 pounds of bass should be harvested from an unfertilized, 1-surface-acre pond per year. According to Table 5, below, approximately 36 pounds of bluegill/redear sunfish should be harvested from an unfertilized, 1-surface-acre pond per year. So, a combined total of approximately 50 pounds of fish should be harvested from an unfertilized, 1-surface-acre pond per year.

Remember, for a pond to remain in balance, some fish must be harvested, and bass must be harvested at a much lower rate than bluegill/redear sunfish, so that bass are present in sufficient numbers to prevent bluegill/redear sunfish overcrowding. **A good rule of thumb is: for every pound of bass harvested, 3-5 pounds of bluegill/redear sunfish should be harvested.**

---

*Carrying capacity refers to the maximum weight of fish (in pounds) that a pond can support during a set time period.*

---

On the average, the pounds of fish harvested in a year should be no more than half of the pond's yearly carrying capacity.

Not harvesting fish can be as harmful to pond balance as overharvesting them.

Surface acres	Fertilized ponds			Unfertilized ponds		
	½	1	2	½	1	2
Total carrying capacity in pounds	200	400	800	50	100	200

**Table 3.**

**Total carrying capacity**

(Total carrying capacity of a pond is the combined weight of bluegill/sunfish and bass.)

Surface acres	Fertilized ponds			Unfertilized ponds		
	½	1	2	½	1	2
Yearly harvest in pounds	18	35	70	6	12	24
Monthly harvest in pounds	1½	3	6	½	1	2

**Table 4.**

**Recommended harvest for bass**

Surface acres	Fertilized ponds			Unfertilized ponds		
	½	1	2	½	1	2
Yearly harvest in pounds	82	165	330	18	36	72
Monthly harvest in pounds	6½	14	29	1½	3	6

**Table 5.**

**Recommended harvest for bluegill/sunfish**

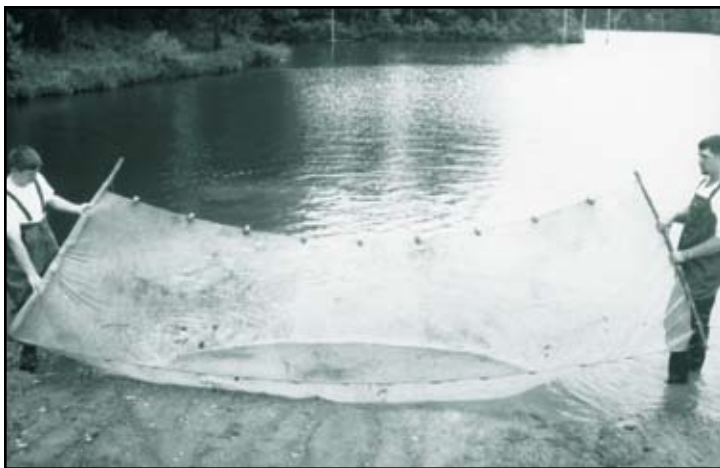

*When seining, the net should be allowed to arch in a half-moon shape so fish cannot easily swim around it.*

### *When to harvest*

No fishing should take place the first year after bass and bluegill are stocked. Bass should not be harvested (removed) for approximately two years after they have been stocked, or until they have reached at least 12 inches. Catch-and-release of bass can be enjoyed after the first year as long as they are handled gently. Bream (bluegill/redear sunfish) may be harvested after the first year of stocking. These time limits allow stocked fish the opportunity to spawn, which will bring the pond into balance and toward carrying capacity.

It is important to space fish harvesting out evenly throughout the year. An exceptionally high harvest in a short period of time will cause a pond to become unbalanced because the fish will be removed faster than they can replace themselves. To maintain quality fishing, and for good management, fish should be harvested regularly and in moderate numbers, with most of the harvested fish being bluegill. **Remember the rule of thumb: 3-5 pounds of bluegill/redear sunfish should be harvested for each pound of bass harvested.** And remember also, if no bass are harvested, a bass-crowded condition is likely to occur.

If channel catfish are stocked they can be harvested whenever they reach edible size. At proper stocking rates, channel catfish generally do not affect the balance of the bass and bluegill population. If catfish reproduce, few offspring usually survive because of bass predation. Restock with 8- to 10-inch catfish when most of the originally stocked catfish have been harvested. Do not overstock catfish since this will lead to poor growth, and possible disease problems.

### *Monitoring pond balance*

To determine whether a pond's fish population is in balance, the pond owner can either sample the fish present by seining (pronounced "sane-ing") or by keeping track of the fish caught, harvested and released.

### *Monitoring pond balance by seining*

This method is effective for ponds with bass/bluegill populations that are at least two years old. Seining to monitor for pond balance should be done during the summer months (June – August) as spawning has occurred by this time. Using a 15-20 foot seine (four feet deep with a ¼-inch mesh), make 3-5 passes (hauls) per acre in areas (up to four feet deep) along the shoreline and record the catch. Allow the seine to arch (in a half-moon shape) so that the fish cannot easily swim around it (see photographs at left). The fish caught in the seine hauls provide information on the reproductive success and balance of the fish in the pond and can also help determine if there are unwanted fish in the pond. Generally, when the seine hauls yield both largemouth bass fingerlings and recently hatched bluegill fry, the pond is in balance. If the seine hauls show no recent reproduction of either largemouth bass or bluegill, but has many bluegill fingerlings that are in poor condition, the fish population is unbalanced. Table 6 on the next page gives some management recommendations based on the contents of multiple seine hauls.



**Table 6.**  
*Evaluating pond balance using seine contents*

Type of fish	Conclusion	Recommendations
1. Many recently hatched bluegill, a few intermediate bluegill (3-5 inches), and young-of-year (fingerling) bass	Fish population in balance (See photograph below.)	Follow normal management practices.
2. No recently hatched bluegill, numerous intermediate bluegill (3-5 inches), and few or no fingerling bass	Bluegill crowded (See photograph below.)	Remove intermediate bluegill by any method <sup>1</sup> and/or stock 20-30 bass (10-12 inches) per surface acre.
3. Many recently hatched bluegill, no or few intermediate bluegill (3-5 inches), and numerous fingerling bass	Bass crowded (See photograph below.)	Harvest approximately 35 pounds of bass (50 bass, 12 inches or less) per acre over a 3-4 month period.
4. No game fish present, no recently hatched bluegill, and no or few intermediate bluegill, unwanted species such as carp, bullheads, shad, green sunfish, tadpoles, etc. present	Pond seriously out of balance (See photographs on the next page.)	Eradicate fish by draining or rotenone, and restock. <sup>2</sup>

<sup>1</sup> See *Removing fish from overcrowded ponds* (24-25).

<sup>2</sup> See *Reclaiming unproductive ponds* (26).

### **Monitoring pond balance by angling (fishing)**

If your pond has been stocked for two years or more, recording angler catch data is another way of studying the fish population to identify any problems. Keep a log of the fish lengths, and if possible, weights of all fish caught, harvested, and released. Table 7 on the page 24 gives some possible catch combinations by rod and reel with fish condition and management recommendations.

When pond owners are able to catch ample numbers of various sizes of bass and bluegill, the pond is probably in balance. When only a few large bass and many small bluegills are caught, the pond is probably overcrowded with bluegill. If fishing produces large numbers of small bass and large bluegill, bass may be overcrowded. If the pond is overcrowded with catfish, they will usually have large heads and small bodies, and harvest of catfish should be increased to allow for healthy growth of the remaining catfish. For further assistance with managing your fish population, contact a fisheries biologist. See *Seeking assistance* (44).

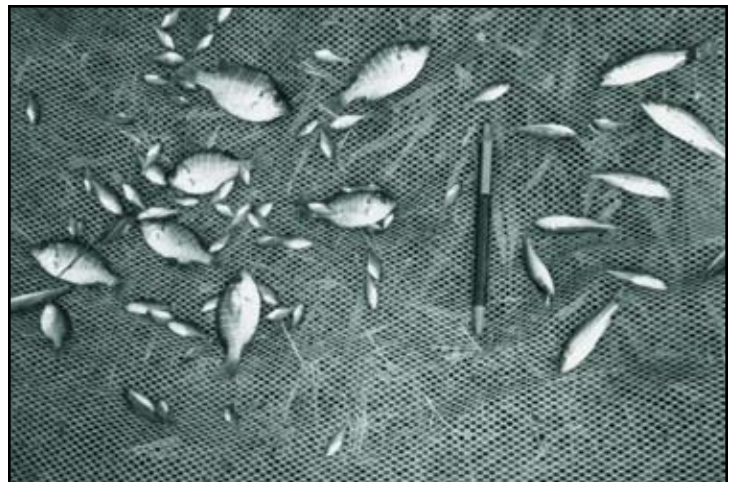

*Sample results from a balanced pond. (See number 1 in table above.)*



*Sample results from a bass-crowded pond. (See number 3 in table above.)*



*Sample results from a bluegill-crowded pond. (See number 2 in table above.)*



**Table 7.**  
*Evaluating pond balance by angling*

Fish caught	Condition	Recommendations
1. Bass - various sizes (up to 1-2 lbs. or larger) Bluegill - various sizes (5-8 inches)	Fish population in balance	Follow normal management practices.
2. Bass - few caught, but large (2 lbs. or larger) Bluegill - few harvestable size and few large: many 3-5 inches	Bluegill crowded	Remove excess 3-5 inch bluegill by rod and reel, seining or trapping, etc. <sup>1</sup> Do not harvest any bass. Stock 20-30 bass (10-12 inches) per acre.
3. Bass - numerous, but many are small (less than 1 lb. or 12 inches) and thin. Some bass may have large heads and thin bodies. Bluegill - few, but larger (7-10 inches) and robust	Bass crowded	Fish more for bass, keep smaller sizes for more quality bass <sup>1</sup> . Do not harvest any bluegill. For quality bluegill, maintain this population.
4. Few harvestable size bluegill (most 3-5 inches). Unwanted species present (crappie, bullheads, green sunfish common carp, etc.) Few bass caught but usually large (2 lbs. or larger)	Unbalanced population dominated by unwanted species	Kill existing fish population and restock <sup>2</sup> .

<sup>1</sup> See *Removing fish from overcrowded ponds* (24-25)

<sup>2</sup> See *Reclaiming unproductive ponds* (26)



*Sample results from an unbalanced pond with (undesirable) green sunfish and intermediate, stunted bluegill. (See number 4 in Table 6 on previous page.)*



*Sample results from an unbalanced pond with no bluegill fry or bass fingerlings. Frogs and crawfish are present. (See number 4 in Table 6 on previous page.)*

### **Removing fish from overcrowded ponds**

If results from seining or angling show that your pond is overcrowded, fish will have to be removed to restore pond fish balance. This can be done with chemicals, wire traps, seines or increased fishing effort. Another method for controlling overcrowded fish such as bluegill is to draw down the water level thereby concentrating the bluegill for bass to feed on (see next page).

The number of small bluegill that needs to be removed from a bluegill-crowded pond depends on the degree of crowding. If the fish average five inches in length, it may be necessary to remove only a few hundred per surface acre. If the fish average less than four inches in length, it may be necessary to remove more than a thousand per surface acre.

Removing fish from a bass-crowded pond is usually not as difficult. Basscrowded ponds are usually older, established ponds that are overpopulated with bass that are 7-12 inches in length. In these cases, remove 50 (12-inch or smaller) bass per surface acre over a 3-4 month period. If remaining bass do not increase in size after about six months, an additional 25 (12-inch or smaller) bass per surface acre should be removed. Once the size of bass increases, the harvest guidelines in Table 4 (page 21) should be followed.

### ***Partial removal with chemicals***

Treatment with chemicals is the only practical method in larger ponds where sizable quantities of fish must be removed. In brief, the treatment consists of lowering the water several feet where possible and treating the remaining shallow water areas and shoreline with rotenone, a restricted-use pesticide. Several treatments may be necessary to remove enough fish without endangering the entire fish population.

Ponds are often so severely overcrowded that thinning is impractical. In these cases, eliminating all of the fish in the pond and restocking may be the only solution. See *Reclaiming unproductive ponds* (26-27). For additional information about using rotenone, contact a TWRA fisheries biologist or UT Extension Agent. See *Seeking assistance* (44-45).

### ***Partial removal with wire traps***

When properly used, wire traps are valuable for removing small bluegill from overcrowded populations. The mouth opening or entrance should be at least 1.5 inches in diameter. If a larger opening is required to trap larger sized bluegill, modifications can be made to enlarge the opening. A crawfish trap, with an opening of about 2.5 inches, can also be used. Note that both a modified trap and crawfish trap can only be used by the pond owner in his private pond. They are illegal to use in public waters.

Attach the traps to the bank by string or wire, and submerge the trap into the water, preferably near structure such as fish attractors. Baiting the trap with commercial fish food or bread usually increases the catch rate.

### ***Partial removal with seines***

Using a 30-40 foot seine with a ½-inch mesh, make as many passes (hauls) as necessary to remove small bluegill as mentioned on the previous page. In waters no more than five feet deep, the seine should be allowed to arch (in a half-moon shape) so that fish cannot easily swim around it. Fish can be removed weekly in late summer and early fall.

### ***Drawdown***

In many cases, a winter drawdown can correct an overcrowded bluegill population if the pond contains bass. This technique consists of reducing the water level from one-third to one-half the normal pond level from mid-November through February. This concentrates the overcrowded bluegills, making them more vulnerable to bass predation. This drawdown technique may need to be done more than once, but if overcrowding persists, the pond should be drained or reclaimed, and restocked with the correct bass to bluegill ratio. See *Reclaiming unproductive ponds* (26-27).

Using too much rotenone can cause a complete fish kill, so for partial treatment it should be used with extreme caution.

All state and federal regulations regarding chemical use must be followed.

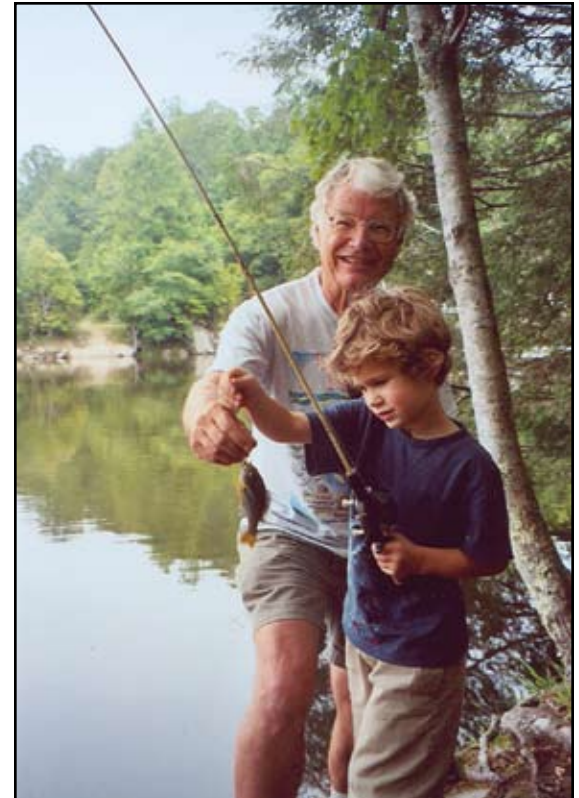

*Photo by Nancy Coutant*

***Wire fish trap***

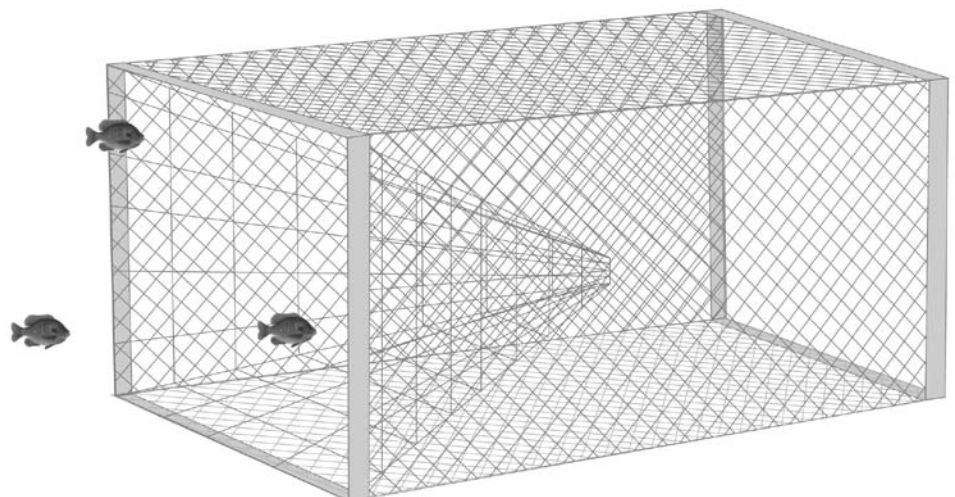



# RECLAIMING UNPRODUCTIVE PONDS



Photo by Dave Rizzuto

When ponds become unbalanced, poor fishing can be expected. Poor location, improper construction, overstocking, stocking the wrong species, improper harvesting and failure to manage have all resulted in hundreds of unproductive fishing ponds. However, even when good management practices are used, some ponds fail to produce satisfactory fishing. Two techniques used to determine the fish population balance are seining and angling (fishing). See *Managing fish populations* (20-25).

Many ponds, regardless of their present use, are potentially good fishing ponds. With proper planning and care, ponds that have been used for other purposes as well as ponds that have previously been used primarily for fishing, can be made into excellent fishing waters.

## *Physical characteristics*

When reclaiming a pond for fishing, also called renovation, its physical characteristics should be evaluated. To avoid siltation and muddy water, the watershed that drains into the pond should have good ground cover. It should also be in an area with the correct watershed ratio, so that runoff is not excessive. Otherwise, the pond owner should consider digging a diversion ditch around the pond. For more information, see *Drainage and water source* (2).

Ponds with large areas of shallow water (less than 3 feet) should be deepened. See *Pond and shoreline depth* (2). Vegetation such as willows, cattails or nuisance aquatic weeds should be removed from the dam and around the shoreline. See *Aquatic weed control* (14-18).

## *Draining pond to reclaim*

Before eradicating existing fish populations contact a fisheries biologist to determine if the problem may be solved by other means. However, in ponds seriously overcrowded with bluegill, and few or no bass, or undesirable species such as green sunfish or bullheads are present, all fish in the pond should be eliminated and the pond restocked. The most economical way to eliminate, or eradicate, the fish is to completely drain the pond with a drain pipe, siphon or pump. If complete draining of the pond is not possible, a fish toxicant will need to be applied. If the pond is drained, any remaining pools or puddles of water should be treated with the fish toxicant to ensure the elimination of all fish. The pond owner may want to consider the availability of water to at least partially refill the pond, in order to restock with bluegill in the fall.

## *Chemical removal of unbalanced fish populations*

Rotenone, a fish toxicant, is the chemical most commonly used to eradicate undesirable fish populations, and is available at some farm and chemical supply stores. **It is a “restricted-use pesticide,” and cannot be purchased without a private pesticide applicator’s certificate. This certificate can be obtained from your county UT Extension agent (see page 45).**

When applied according to label directions, rotenone is nontoxic to wildlife, pets, or livestock, with the exception of swine, which are sensitive to rotenone. However, as an added precaution minimize animal activity in the treated water.

The preferred time to eradicate fish is late summer or early fall (August-September) when water temperature is above 70° F, which will allow the rotenone to detoxify faster, usually within 4-5 days. Other reasons to eradicate at this time are water levels are usually lower, and the time between the renovation and restocking in the fall is reduced, which minimizes the chance the pond will be contaminated by unwanted fish before restocking.

Before treating, it is more efficient and economical to first lower the water level as much as possible by draining. This not only reduces the cost of the treatment, it also concentrates the fish into a smaller area. The cost and amount of a rotenone treatment depends on the volume of water in the pond. Therefore, pond owners need to know the water volume of their pond measured in acre-feet. See *Determining water volume* (43). Once the water is lowered, be sure to close off any drain or overflow pipes so that no rotenone will escape from the pond and flow downstream into public waters. It is unlawful to use rotenone in public waters of the state.

Rotenone is a restricted-use pesticide.

Pond owners must contact the UT Extension Agent in their county to get a private pesticide applicator’s certificate to purchase Rotenone. See Seeking assistance page 45.



## Applying rotenone

Before applying rotenone, always read and follow label directions for proper use, including application rates and personal protective equipment requirements. The information provided here is intended to clarify and supplement that which is found on the product label.

Rotenone can be purchased in liquid or powdered formulations, with most containing at least 5 percent rotenone, although some liquid formulations contain 2.5 percent in a synergized form. Before application, both formulations must be diluted with water. For the powdered formulations, mix thoroughly with water only until a “soupy” mixture is obtained. Since powdered rotenone is very dusty, be sure to wear a protective mask. Exposure and inhalation of the dust can cause irritation to the eyes, throat and nose. Liquid formulations, which are easier to handle and get into solution, should be diluted with sufficient water to adequately treat the entire pond basin.

The mixture should be evenly distributed over the pond surface. For ponds smaller than one-half acre, the mixture can be sprayed from the shoreline. For larger ponds, a boat should be used to get a better distribution throughout the water column. The mixture can also be dripped into the prop wash of an outboard motor to get better mixing. Application in a random “S” or “zig-zag” pattern will help maximize distribution. The idea is to do whatever is necessary to ensure proper mixing of the rotenone mixture with the remaining pond water. Be sure to treat any isolated coves, pools or puddles in the pond basin. Many small fish can survive in these areas, and must be eliminated to accomplish a successful renovation. Survival of only a few unwanted fish can defeat the purpose and effort of the renovation.

The amount of rotenone required will vary depending on the acre-foot of water being treated (acre-feet = surface acres x average depth, see page 43), water temperature, and the species being targeted. Therefore, application rates on the label should be followed closely.

In general, 5 percent liquid rotenone applied at the rate of two pints per acre-foot of water, or 5 percent powdered rotenone applied at two pounds per acre-foot will eradicate bass and bream in waters with temperatures above 70°F. If bullhead catfish (page 8) and/or common carp are present, the above rates should be doubled.

After treatment most fish will die and come to the surface within 24 hours, although fish may continue to surface for a couple of days. Since rotenone is not approved by the EPA or Food and Drug Administration for human consumption, the dying or dead fish should not be eaten. To reduce odor problems, larger fish can be disposed of by burying them, but cover the fish with lime before filling in the hole. The lime will reduce odor and pest problems.

## When to restock

After treatment, the time it takes for rotenone to break down (detoxify) is relatively short, depending on the water temperature. If the water temperature is above 70° F, the pond can be restocked in two to three weeks. If it's below 70°F, it can take 4 to 6 weeks before restocking is safe. To be sure that it's safe to restock, place some small bluegill or fathead minnows in a small cage or minnow bucket. If the fish survive 1-2 days, it is safe to restock.

For additional information about using rotenone, fish eradication and reclaiming ponds, contact a TWRA fisheries biologist or UT Extension Agent. See *Seeking assistance* (44-45).

Rotenone should not be used in ponds that flow constantly into streams, ponds or lakes. Users of rotenone are always responsible for its effects if it drifts to private or public property.

Rotenone must always be handled according to the instructions provided on the label and manufacturer's instructions and safety precautions should be strictly followed when preparing and applying it.

All state and federal regulations regarding chemical use must be followed.

# FISH KILLS

Watch for early signs of a possible fish kill caused by low oxygen levels such as fish gulping for air at the surface of the water in the early morning.

The term “fish kill” is used to describe a sudden die-off of a large number of fish. Fish die from a variety of natural causes throughout the year. Observing a few dead fish in a pond, especially in the spring, is not uncommon and is no reason for concern unless it continues for several days. When fish die in large numbers, there is reason for concern, and the pond owner should contact a fisheries biologist or UT Extension agent to determine the cause and recommend a plan to help reduce additional losses. Fish kills can result from a variety of causes such as toxic run-off, dissolved oxygen (D.O.) problems, and disease or parasite infections. Once dead fish are seen, it is usually too late to do anything, but knowing the possible causes and measures that can be taken, the pond owner can take steps to prevent future fish kills or reduce their severity.

## Toxic run-off

Many agricultural and residential pesticides and herbicides used on livestock, crops, and lawns can be highly toxic to fish. Therefore, use extreme caution when using these chemicals near ponds. If rain is expected, they should not be used at all near the pond or in the watershed. In addition, do not allow livestock treated with pesticides access to the pond. Some residential pesticides are available which are non-toxic to fish, and these are recommended if they are to be used near a pond. It is difficult to know with certainty that a fish kill was caused by toxic chemicals, but one clue is that all species of fish are usually affected in a relative short period of time, starting with the smaller fish. If frogs or turtles are present, they too are normally affected. Analysis of water samples can be expensive, and by the time the analysis is conducted, the chemical may be broken down to the point that the analysis will not give conclusive results.

While not directly toxic to fish, the run-off or direct deposit of animal waste from livestock, ducks or geese will increase the nutrients in the pond which can cause heavy algae “blooms”, aquatic weed growth, and increase the oxygen demand in the water when the waste decomposes (breaks down). These can lead to fish kills as discussed below.

## Dissolved Oxygen

One of the leading causes of fish kills is oxygen depletion or deficiency, and usually occurs during the hot summer months (July through September) as warm water contains less dissolved oxygen (D.O.). Most of the oxygen in pond water is produced through a process called photosynthesis, through which tiny plants called phytoplankton or microscopic green algae produce oxygen in the presence of sunlight. Since sunlight is required, oxygen is produced only during daylight hours. At night, photosynthesis ceases, and oxygen levels decline as it is being consumed by fish, phytoplankton and other aquatic life through respiration. As a result, oxygen levels are lowest just prior to sunrise.

Most of the time there is a balance between the amount of oxygen produced and how much is used. When this balance is upset, the oxygen concentration can become low enough to stress or kill fish. Typically, the D.O. level is 8-10 parts per million (ppm) or higher during the day. When the level drops below 5 ppm, fish can become stressed, and below 3 ppm, a fish kill may occur.

One way to recognize oxygen depletion is to observe the pond immediately before sunrise. Fish, usually adult size, will usually be seen on the surface gulping for oxygen or near the shoreline. If disturbed, they dive but soon return to the surface. If oxygen is not low enough to kill fish, the fish at the surface in the early morning will return to deeper water as the oxygen builds up during the day through photosynthesis. If fish of different species die overnight or in the early morning, there is probably a dissolved oxygen problem. Larger fish are normally affected first. In ponds where fish are fed, fish often give warning signs of low oxygen by not eating.

The oxygen balance can be upset in several ways. In a fertile pond, phytoplankton multiplies as summer progresses. If excess nutrients are added to the pond (e.g. excessive feeding, run-off or direct deposit of animal waste, over fertilization, etc.) the algae can become so dense that adequate sunlight cannot penetrate beyond the first few feet of water. As a result, the microscopic algae,



*Fish kill caused by a lack of dissolved oxygen.*

and therefore the oxygen, become restricted to this upper layer of water, leaving a large volume of water below this layer deficient in oxygen production. Eventually, the demand for oxygen during night time respiration will exceed what is produced in the upper, narrow layer of water, resulting in a possible fish kill or undesirable stress on fish.

Several days of cloudy weather during the summer or early fall can also cause a fish kill. The reduced sunlight during cloud cover restricts sunlight penetration to the upper layer of water. The algae in the deeper water no longer receive adequate sunlight and can die off quickly. When the algae die, not only does the pond lose its main source of oxygen, but the decaying algae use considerable amounts of oxygen during decomposition and fish become stressed or die. A sudden die-off of algae can also occur after pond treatments with certain algacides and other chemicals. Ponds that experience an algae die-off will often have a change in water color from green to black or brown, and a foul odor may also be noticeable.

To reduce the chance of an algae die-off, the amount of nutrients entering the pond must be controlled and care should be taken not to over fertilize the pond during the summer. See *Fertilizing your pond* (9-12). A good rule of thumb is to be able to see a white object below the surface at about 16-18 inches.

Oxygen depletion can sometimes occur if the pond water becomes very muddy from runoff after a heavy rain, from livestock wading in the pond or during periods of drought, as the same poundage of fish are in a reduced volume of water. Filamentous algae (pond scum) or duckweed covering the entire surface of the pond will block sunlight from the microscopic algae, and as a result less oxygen is produced in the pond by way of photosynthesis.

As mentioned previously, since the decay of plant material in a pond will consume oxygen as it decomposes, care should be taken not to kill too much of the plants at one time when applying aquatic herbicides or algicides. Treat only one-fourth to one-third of the pond at a time, and wait 7-10 days before treating another fourth or third. Because of an increase risk of oxygen depletion during the summer, it is recommended that aquatic herbicides be applied during the spring when water temperatures are lower and plants are less abundant. See *Aquatic weed control* (14-18).

The most serious kind of oxygen depletion is referred to as a pond "turnover" or more properly termed, destratification. During the summer, surface water of the pond becomes less dense as it warms and it floats over the cooler, denser (heavier) water below. A thin layer that separates this warm and cool water is called the thermocline. This separation of water layers is referred to as stratification (see illustration at right). All the oxygen is produced in the warm, upper layer, and may not mix with the cooler, bottom water for weeks, especially in deep water ponds. Depending on the amount of time the pond stays stratified (separate layers), all the oxygen can be used up in the bottom layer. As fall approaches, the upper water layer cools down and the density between it and the bottom layer is reduced. As the upper layer becomes heavier when it cools down, it will sink and mix with the oxygen-deficient, bottom layer. Most often, a cold rain or a thunderstorm with wind will cool the upper layer and cause a sudden mixing (turnover) of the two layers. If the bottom layer is relatively large compared to the upper layer, then the net result is a dilution of the oxygen, and a fish kill could result. To make matters worse; the microscopic algae (oxygen producers) usually die at the same time. This problem can be reduced by not building a pond too deep (see *Pond depth*, page 2), or by installing a destratification system, as mentioned on the following page.

### **Aeration**

When any of the above symptoms (fish gulping at the surface, water color change, fish stop feeding, etc.) are observed, the pond should be aerated immediately, and if fish are fed, stop feeding until the proper oxygen level is restored. The following methods can be used in an emergency to help aerate the pond. Use a water/irrigation pump to draw water from just beneath the surface and direct the spray (not a stream of water) into the air and back into the pond. Angle the discharge parallel to the shoreline and establish a circular motion around the

Chlorinated or "city water," which contains chlorine or chloramine, should not be used in ponds because these compounds are toxic to fish.



Photo by Dave Rizzuto

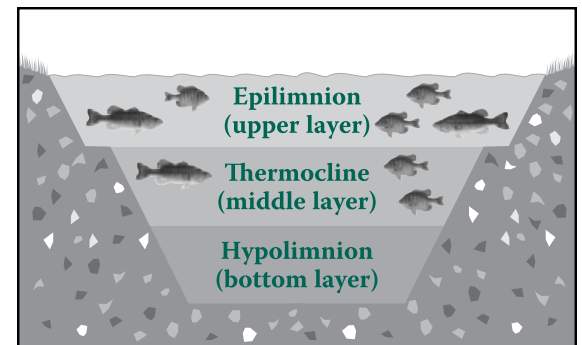

**Stratification of water layers**





*An example of a paddlewheel aerator*



*A surface spray aerator at work*

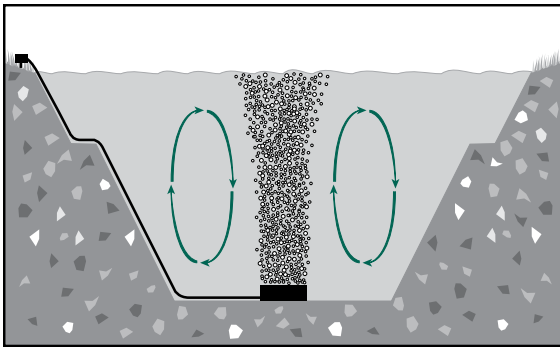

*A destratification system can keep the water in a pond circulating so the pond will not stratify into layers. Two types of systems are available; those that move the water from the pond bottom to the surface and those that force air and water down from the surface.*

pond. If available, add aerated water from a well. Since well water is usually very low in oxygen content, it must be aerated by spraying it through the air into the pond. Aeration is especially important at night when oxygen levels are the lowest, and during periods of cloudy weather.

Backing a tractor-powered rotary mower (bushhog) into the pond and stirring the water with the blades, or running an outboard motor around the pond can help in small ponds. If an algae die-off is suspected to have caused the oxygen problem as previously discussed, and sunshine is forecasted for the next few days, 20 pounds of triple superphosphate, or 40 pounds of superphosphate per acre can be quickly added to stimulate the production of phytoplankton and therefore improve oxygen production. If symptoms of oxygen depletion (fish gulping on the surface) are seen early enough, there are products available such as AquaKler™\* that when used as directed, will release oxygen and are non-toxic to fish. \*Note: Use of product names is for informational purposes only, and does not imply endorsement of a product to the exclusion of others that may be of similar and suitable composition. Also, it does not guarantee or warrant the standard of the product.

Once the oxygen problem has passed, the pond management program should be reviewed and the cause(s) of the low oxygen eliminated. While prevention of the previously mentioned situations through proper management will reduce the chance of an oxygen depletion problem, eventually many ponds will experience some type of fish kill or turnover.

Ponds that have recurring oxygen problems may require an aeration system that will increase oxygen levels during critical periods, and/or a destratification system which will help prevent water-layer stratification as mentioned previously. A variety of aeration and destratification systems are available, including surface spray or pump spray aerators, paddlewheel aerators, and diffused air systems. Most decorative fountains used in ponds are not very effective in pond aeration. Since there are advantages and disadvantages to each system, the pond owner should research the different systems to find which one best fits their pond and budget. Aerators are not intended to aerate the entire pond, but to increase oxygen levels in a portion of the pond in order to reduce the negative impact on fish. While the sizes of aerators vary, those with a capacity of at least one to two horsepower per acre are recommended. For ponds larger than five acres or deeper than 12 feet, a diffuser-type destratification system placed along the pond bottom is more efficient at reducing the risk of a pond turnover (see illustration at left). It's important to note that a destratification system does not provide aeration but keeps the water in the pond circulating so the pond will not stratify into separate layers (see page 29). Aeration systems and equipment are available from many aeration supply companies, and aquaculture supply stores.

### ***Diseases and Parasites***

Fish diseases or parasites generally do not cause extensive fish kills in balanced bass/bluegill ponds, and an occasional sore may be seen on some fish as a result of spawning activities or following an injury. It's normal for a few fish to occasionally die, but fish kills caused by diseases usually occur when fish are stressed by overstocking or overcrowding, poor water quality, malnutrition, or inconsistent feeding. Although some chemicals or medicated feed can be used to treat certain diseases and parasites, this treatment is often expensive, difficult, and usually only partly successful. In most cases it's best to just let the disease outbreak run its course, since it will usually disappear after a short time. The best control for any disease is prevention. These preventive measures include stocking disease-free fish at recommended rates, fishing (and harvesting) the pond properly, maintaining good water quality (using aeration if necessary), and excluding wild fish from the pond. Generally, fish diseases are difficult to diagnose and usually requires the infected fish to be examined by a fish disease expert. This usually requires dying fish rather than fish already dead to be collected and sent to a fish disease laboratory. Symptoms and behaviors of fish with diseases or parasites may include bloody body lesions and sores, excess mucus, decaying fins, bulging or cloudy eyes, grayish-white fuzzy growth on body or fins, swollen fluid-filled body cavity, small white or black spots on or under the skin (see pages 31-32) and swimming weakly, erratically, or in spirals. Once caught, it's

recommended to never throw fish that have any of these symptoms back into the pond.

Fish in the wild normally have a variety of parasites, and show no signs or negative effects unless the infection or parasitism is extremely heavy. It is difficult to get rid of all parasites in a pond since they are readily introduced from many sources. As noted above, maintaining good water quality and preventing overcrowding are the best ways to maintain healthy fish populations. Occasionally, anglers catch fish that have small yellowish or black “bumps” or nodules on their fins, under the skin, or in the flesh. Known as the yellow grub and black grub, or black-spot disease, these two internal parasites are the most frequently observed by anglers (see page 32). Many times, the grubs are only evident when the fish is filleted instead of scaled during the cleaning process. These grubs are the larval stage of a trematode worm that goes through a complex life cycle involving snails, fish, and fish-eating birds such as herons or kingfishers.

Although unpleasant to look at, these parasites pose no threat to humans if the fish are properly cleaned and thoroughly cooked. The affected area can be cut away, and the rest of the fish cooked and eaten.

To reduce or limit grub infections, the life cycle must be broken. This requires snails or fish-eating birds to be controlled because there is no chemical treatment available to eliminate these parasites once they are encysted in the fish. Unless the parasitized fish is eaten by a fish-eating bird in order to complete the trematodes life cycle, the grub can stay encysted for several years. Snails can be controlled by eliminating aquatic weeds around the shoreline, since this reduces snail habitat and food. Redear sunfish (shellcracker) consume snails; therefore they can be stocked at 40-60 (4-6 inches) per acre as a biological control method to help reduce the snail population. Although some chemicals have been used to control snails, this can have limited success since snails can avoid the chemical by burrowing into the pond bottom. While not always practical, the draining and complete drying for several weeks of the pond will reduce snail numbers, and may be required when grub infestation is severe.

Since all fish-eating birds are federally protected, techniques pond owners can use to deter these birds are usually limited to frightening devices and physical barriers. Some of the frightening devices include noise-making propane cannons and shot shells, “eye spot” balloons, flags, remote-control boats, heron or owl decoys, and scarecrows. Unfortunately, these birds can get use to these visual devices when used continuously. The use of a large active dog to deter the birds can be highly effective, especially at night. While impractical for some pond owners, physical barriers that may deter the birds include netting, wire or string grids around the pond, and fencing. Deep water (at least 20 inches) at the pond edge will also discourage herons that feed in shallow water. See *Water birds* (37).

### ***Maintaining balance after a fish kill***

If possible, the pond owner should estimate the numbers, weights and/or sizes for each species of fish that dies. This estimate will be helpful to a fisheries biologist in determining the severity of the kill and whether the fish population can recover naturally. If the number of dead fish seems overwhelming, make the estimates within a 10x10-foot area, and apply this to the total affected area. The severity of a fish kill determines what action is needed to restore the pond to a productive condition. If only a few large fish are lost, the pond balance may not be endangered. In many cases, a pond will return to a productive state if enough bass fingerlings survive to control the bluegill fry that may spawn following a fish kill. If most of the bass do not survive, overpopulation of bluegill will be impossible to prevent. When a large number of fish die, particularly large numbers of bass, it is usually best to eliminate the remaining fish by draining the pond, or by applying rotenone in the fall, and restocking. See *Reclaiming unproductive ponds* (26-27).

For additional information about fish kills, contact a TWRA fisheries biologist or a UT Extension agent. See *Seeking assistance* (44-45).

Some of the more common diseases and parasites are pictured below and on the following page.

*Photos Courtesy of Southeastern Cooperative Fish Disease Project*



***Aeromonas – Irregular-margined reddish sores or lesions on the sides of fish.***



***Fungus – “Cotton-like” or “fur-like” in appearance these infections generally occur secondarily to some injury or disease.***



***Epistylis (“red sore disease”) – Patches of red sores over the body. Scales and spines of infected fish may be eroded away.***





**Black Grub** (“black spot disease”) – Small black pigmented spots that resemble black pepper under the skin or in the flesh.



**Costia** (“blue slime disease”) – Blue-gray film over the body surface, associated with excess mucus/slime being produced by the fish.



**Philometra** (“popeye disease”) – Parasitic worm that matures behind the eye causing the eye to bulge, and can result in the loss of the eye.



**Yellow Grub** – Small yellow or cream-colored nodules or “bumps” under the skin on most any part of the body, and in the flesh.



**Anchor Worm** – Red or cream-colored thread-like parasite protruding from the base of scales or fins. Area around entry wound reddish and/or surrounded by fungus.



**“Hole-in-the-head” disease** – White or reddish raised area between the eyes of catfish that develops into a larger “hole-in-the-head” lesion.



**Ich** (“white spot disease”). Pinhead sized white spots that resemble salt sprinkled over the body and fins. Excess mucus/slime may be produced.



It is not necessary to feed fish in a naturally fertile or artificially fertilized bass and bluegill pond, as enough food organisms are produced to support fish populations. However, feeding can be done to increase fish growth in catfish-only ponds, hybrid sunfish ponds, and infertile bluegill/bass ponds. Normally, bass will not accept feed, as they start eating fish (in this case bluegill) at about two-and-a-half inches long. Bass will benefit from feeding the bluegill, because their reproductive potential is normally increased, thereby increasing forage for the bass. While feeding fish can increase the pounds of harvestable fish, and fish size, it should be done with caution, and the pond owner should be aware of the risks discussed below. It should be noted that grass carp will consume floating fish food. In ponds where supplemental feeding of bluegill and catfish occurs and grass carp are present, you may want to consider other aquatic weed control options, since feeding the grass carp will reduce their appetite for aquatic weeds.

### **Risks of feeding**

Feeding fish can cause conditions that threaten fish. It can cause oxygen to be depleted when uneaten food decays and when fish waste quantities increase. This decaying organic matter can also produce a heavy algal bloom, which can cause oxygen levels to drop at night or on cloudy days, and kill fish.

It is important for pond owners who feed their fish to harvest some larger fish regularly because increases of larger fish resulting from feeding will also put a greater demand on oxygen in the pond, which could cause a fish kill. See *Dissolved oxygen* (28). Too many large fish being crowded may also cause a disease outbreak. A permanent aeration device is suggested for all ponds where fish are fed regularly. See *Aeration* (29).

### **How to feed**

Fish should be fed at the same time and location each day in water over three feet deep. It is best to use floating fish food, of appropriate pellet size, to observe the amount of feed being eaten. In training fish to accept fish feed, a “feeding ring” can be very helpful. The ring is typically made of 1.5 inch PVC pipe, and generally 8-10 feet in diameter. The ring should be placed where the water is over three feet deep, and anchored to keep it in place. Once the floating fish food is tossed into the ring, it will remain there until the fish discover and eat it. The ring also prevents the feed from being blown to the shore and wasted. When training, it’s important to not stand over the fish and to avoid fast, erratic movements that will frighten the fish. Move slowly, and if possible, remain out of sight.

As a general rule, only feed fish what they will consume completely in 10-15 minutes. Never feed more than 10 pounds per surface acre a day. Too much uneaten feed can pollute the water. Also, do not double the feed after missing a day of feeding. If fish quit eating, stop feeding for a few days, watch for fish gulping air at the surface or for signs of disease. Feeding can be done by hand or with automatic feeders, which dispense a selected amount of feed on a timed basis throughout the day. Automatic feeders will give the best growth where ponds are unattended for long periods. Automatic fish feeders are available from many aquaculture supply stores and some farm and feed stores.

Taper the feeding rate when the water temperature falls below 55°F to one-fourth the feeding rate during the summer. Do not feed fish during prolonged periods of cloudy weather (summertime), when the water temperature exceeds 90°F, or when fish are stressed for other reasons such as low oxygen in the water, or parasites and disease. See *Fish kills* (28-31). A commercial fish feed containing 30-32 percent protein is recommended, and is available at many farm and feed stores.

It is important for pond owners who feed their fish to harvest some of the larger fish regularly.



Do not overfeed fish.

# MISCELLANEOUS CONSIDERATIONS

## *Leaking ponds*

All new ponds absorb water and appear to be leaking until the bottom soil becomes saturated. Water loss through evaporation is also normal, particularly during dry months. However, if the water level continues to stay lower than expected, the cause should be identified. In some cases, walking behind the dam or levees can reveal soggy or wet soil that may indicate a leak. However, leaks can be difficult to locate when they occur in the pond bottom. Several methods can be used to stop leaks, but can be expensive, and require extensive work, including the drainage of the pond.

If the leak cannot be located, the simplest and least expensive method is usually draining the pond and compacting the existing bottom, or applying at least a 12 inch layer of clay soil and then compacting. If the pond bottom was not compacted when built, the leak may be stopped by simply compacting the bottom with a sheepsfoot roller. If it was compacted during construction, then the clay soil should be applied and compacted well with a sheepsfoot roller to thickness of at least 8 inches. The deeper the pond, the thicker the seal should be. If any tree stumps or large rocks are present these should be removed and the cavities completely filled. If the addition of clay soil and compacting does not stop leaks through the dam, it may be necessary to recore the dam with clay. Trees should not be allowed to grow on the dam or levees, as the tree roots can penetrate through and cause leaks. However, it's usually not recommended to cut trees that are already well established with a substantial root system. If cut, a leak can form when the dead roots decay. Keeping the dam and levees mowed will also help discourage burying animals such as muskrats. See *Muskrats* (38).

The most popular method for fixing a leak is to use a clay material called bentonite. Bentonite can be applied in the water above the area of the leak, if the area can be specifically located and the leak is not too large. Once in the water, bentonite expands to many times its original volume, and once it seeps into cracks and crevices in the pond bottom, leakage can be reduced. If the leak can be specifically located, another method of using bentonite is to punch holes into unopened bags of bentonite and then drop the bags as close to the leak as possible. As water enters the bags through the holes, the bags will burst and bentonite will flow into the leak, helping to impede water flow through the sediment.

However, bentonite works best when it is disked into a dry pond bottom and then compacted well. Application rates range from 1-3 pounds of bentonite per square foot of pond bottom. When applying in areas over 10 feet deep, more bentonite may be required. Bentonite can be located by contacting farm supply stores, well drilling companies or construction companies.

Some commercially and professionally available pond sealing products can be broadcasted or poured into the pond. Many of these products are bentonite-based or are liquid polymer emulsions.

In ponds with a high quantity of calcium in the soil, and having at least 15 percent clay content, the application of a dispersant such as soda ash (sodium carbonate) can reduce leakage. Dispersants aid in changing the soil structure, making it less permeable to water. Application rates range from 2,000-4,000 pounds of soda ash per acre disked into the top four inches of soil and compacted well.

Another method is to install pond liners, which are available from commercial pond and aquaculture dealers. Liners are quite effective when installed correctly, but can be expensive depending on the type of material and the amount required.

Proper planning and construction is the best way to avoid leakage problems. See *Pond construction* (1-4). For more information about sealing leaky ponds, contact your local NRCS, TWRA or UT Extension office. See *Seeking assistance* (44-45).



Photo by Doug Markham

## *Muddy water*

Many ponds become muddy at times after a heavy rain, or from wave action against the shoreline, but usually clear up after a short period of time. Occasionally, ponds will become muddy and fail to clear up because of several factors. Continual muddiness not only makes the pond unattractive, but can also impact the fisheries. Muddy water reduces sunlight penetration, which reduces the production of phytoplankton (basics of the food chain), and results in lower oxygen production. In addition, sight-feeding fish such as largemouth bass will be less successful in locating and feeding on prey (bluegill/bream), which can lead to an overcrowded bluegill population. Continual muddy water can also interfere with fish reproduction, fishing success and increase water temperatures. The first step in clearing muddy ponds is to eliminate the source by first inspecting the watershed and shoreline for signs of erosion. After the source is eliminated, the water will usually clear naturally, but may take several weeks or more depending on the soil type in the watershed.

Muddy water can result from several sources, including soil erosion from the shoreline, and/or watershed, from bottom-feeding fish such as common carp or bullhead catfish, from high numbers of crayfish and from livestock wading into the pond. Another cause is the suspension of clay particles which can be more difficult to clear up. Some soils have clay particles that are very small and repel each other because they have the same electrical charge, causing them to remain suspended.

A method for determining the cause of muddy water is to take a sample of the pond water in a clear glass jar and set it out of sunlight. If the water clears in less than a week, the muddiness is probably caused by erosion or animal activity. If the water is still muddy after a week, the problem is likely suspended clay particles. Measures for controlling erosion include planting shoreline grasses, water willow or rip-rapping the shoreline. Any bare ground in the watershed should be planted in a sod producing grass, along with at least a 100-foot wide, vegetative, buffer strip around the pond. In cases of excess water runoff into the pond, either a drainage ditch can be dug around the pond to divert the excess water or the watershed slopes can be terraced.

In the case of animal activity, if common carp or bullheads are the cause they will need to be removed either by draining or treating the pond with the fish toxicant rotenone (see pages 26-27). Crayfish are usually controlled with largemouth bass or channel catfish. Livestock should be fenced out of the pond if fish production is a high priority. If this is not feasible, fence off all but a small corner of the pond for livestock watering. There are designs for constructing gravity-feed watering troughs, fountains and low impact pond entry walkways available from the NRCS (see page 45).

If, after jar test above, the water is still muddy or very cloudy after a week, then suspended clay particles are the likely cause. One of the following techniques below can be used to reduce the levels of suspended clay particles, but should only be used after the cause of the muddiness is corrected. These techniques allow the clay particles to bind or clump together into larger particles which cause them to sink to the bottom.

- Over the entire pond, broadcast agricultural limestone (calcium carbonate) or agricultural gypsum (calcium sulfate) at a rate of 1,000 pounds per surface acre of water. Better results may be obtained if the limestone or gypsum is dissolved in clear water and sprayed over the surface on a calm day. You may wish to consider using half the above rates (500 pounds/acre), wait several days, and determine if additional limestone or gypsum is required. Agricultural limestone and gypsum can be purchased at farm supply stores.
- Spread approximately 2-4 square bales of good hay such as dry green alfalfa or clover (not wheat straw or weeds) per surface acre every two weeks. Bales should be broken apart and scattered around the pond. No more than four applications of hay per year should be applied. This method should not be used during the summer months because it may lead to oxygen depletion and fish kills as the material decomposes. If hay must be

*Pond with muddy water*



*Photo by Bobby Wilson*





used during the summer, the use of supplemental aeration will help prevent a fish kill. An alternative to spreading hay is to anchor or stake solid bales of hay every 30-40 feet along the bank in the water. Replace and anchor new bales every 14 days until the water clears. As with the spreading method above, hay bale applications should not be used more than four times per year, and should not be used during the summer months, unless supplemental aeration is used.

- Broadcast over the pond surface a cottonseed meal and superphosphate fertilizer mixture at a rate of 75 pounds of cottonseed meal and 25 pounds of superphosphate per surface acre. Use caution during the summer months since decomposition of cottonseed meal may lead to oxygen depletion. Cottonseed meal and superphosphate fertilizer can be purchased at farm supply stores.
- Alum (aluminum sulfate) is an effective material for clearing muddy water caused by suspended clay particles. Application rates are typically 100-250 pounds per surface acre. However, alum lowers the pH, which increases acidity of the water, and when used in ponds with low alkalinity (less than 20 mg/l calcium carbonate) it can be harmful to fish and other aquatic life. If used in ponds with low alkalinity, hydrated lime must be added simultaneously with alum at a rate of a half-part of hydrated lime to each part of alum to buffer the effects from increased acidity. It's wise to only use between a third and a half of the application rate of alum (along with the lime if necessary), wait a couple of days, and then determine if additional alum (and lime) is required. Alum is not always available from farm supply stores, but they may be able to direct you to a company that sells it. An alternative is to use a buffered alum product such as Phosclear<sup>®</sup> or BaraClear<sup>®</sup>. These products can be broadcasted evenly across the surface of the pond or in some cases dissolved in clear water and sprayed over the pond. The buffering agent helps prevent the drop in pH, and increased acidity as noted above. However, the water to be treated should have a pH between 6.0 and 8.0. If this product is used in water with a pH over 8.0, it can become toxic to fish. The pH can be checked with a water test kit available at swimming pool supply stores or hardware stores. These alum products can be purchased at some aquaculture supply stores and lake/pond supply stores. Always read and follow directions on the label of alum products.  
*Note: Use of product names is for informational purposes only, and does not imply endorsement of a product to the exclusion of others that may be of similar and suitable composition. Also, it does not guarantee or warrant the standard of the product.*

Remember that if the source of the muddy water is not eliminated first, the above treatments will only be temporary. Contact your TWRA, UT Extension, or NRCS office for more information about clearing muddy water. See *Seeking assistance* (44-45).

### ***Excess Organic Matter/Foul Odors***

Over time, some older ponds develop a buildup of organic matter such as decomposed leaves, aquatic plants, animal waste, and uneaten fish food. In excessive amounts these organics can contribute to foul odors, high ammonia levels, and over time, sludge buildup. To help reduce organic matter, odors, and sludge, there are products containing beneficial bacteria that can be added to the pond to break down and digest the organic buildup. Some of these bacterial products are formulated to also increase water clarity and reduce excess nutrients. Reduced nutrients can lead to reduced aquatic weed or algae growth because there are fewer nutrients available for plant growth. These products can be purchased at aquaculture supply stores and lake/pond supply stores.

# LIVESTOCK AND WILDLIFE IN FISHING PONDS

## Livestock

Many farm ponds have been constructed primarily to provide water for livestock, and fish production is a secondary benefit. Some of the drawbacks to allowing livestock access to a fishing pond are that they trample the shoreline and create problems with erosion. They muddy the water which can limit fish production and their waste can result in excessive nutrients which can result in a fish kill and/or excessive growth of aquatic weeds and algae. In addition, allowing livestock that have been treated with pesticides into the pond can cause a fish kill.

If successful fish production is a high priority, preventing access to the pond by livestock is recommended. There are designs for constructing gravity-feed watering troughs (see illustration on page 3) and fountains, and low impact pond entry walkways available from the NRCS (see page 45). Contact the NRCS about programs that may help defray the cost of installing these alternative watering sources. If preventing access to the pond or one of the optional watering designs is not a realistic option, all but a small section of the pond should be fenced off to limit access to the pond by livestock.

## Wild fish

Pond owners are usually surprised when bullheads, green sunfish, common carp or other fish they have not stocked are caught in their ponds. When rainfall is heavy and the excess water passing from a pond runs into nearby streams, drainage canals or other ponds, fish can easily swim into the pond through the spillway. They usually enter as fingerlings and may go undetected for a year or more. A drop off of at least 1-3 feet at the lower end (outflow) of the spillway can help prevent fish from entering most ponds. Other entryways for wild fish are from emptying bait buckets into the pond, and having someone put in undesirable fish species.

When a new pond is located below an old one, it is difficult to prevent fish from moving to the new pond. This can produce serious complications during initial stocking and afterwards, because untold numbers of bluegill, shiners or other undesirable species can enter the pond when water passes around or over the spillway of the upper pond. This not only disrupts initial stocking rates, but allows future fish introductions into the lower pond. Where wild or undesirable fish have become established, it's usually best to eliminate the entire fish population by draining or by using the fish toxicant rotenone (see pages 26-27). If the undesirable fish species is of a size that can be eaten by bass, then increasing the largemouth bass population can sometimes control their abundance. Besides fishing and catching an undesirable fish species, the presence of them can be checked by using a minnow seine. See *Monitoring pond balance by seining* (22). Whenever fish can enter a pond from other bodies of water in the watershed, the bass populations should be maintained at a high level to safeguard against overpopulation of wild fish. When bass are present in sufficient numbers, the problem of wild fish from upper or lower bodies of water can usually be minimized.

## Water birds

Water birds such as herons, egrets, kingfishers, cormorants and other species which feed on fish are common visitors to Tennessee ponds, and for some pond owners they add to the beauty of the pond. Although some of these birds are intermediate host of fish parasites (see *Diseases and parasites*, 30), in most cases, with the exception of cormorants, these birds will not upset the fish balance because only a small number of fish are eaten. However, some aquatic weeds can possibly be introduced as the bird travels from one pond to another. Cormorants, especially in large flocks, can impact the fish population because of the large number of fish they can eat. Cormorants are black in color and usually swim low in the water.

All water birds (fish-eating birds) are protected by federal law making it illegal to kill or capture them, except in circumstances where fish production at commercial fish farms is affected. However, there are techniques pond owners can use to deter these birds such as frightening devices and physical barriers. Some



Photo by Jim Johnson

All water birds are protected by state and federal laws, making it illegal to kill or capture them.



Photo by Doug Markham

of the frightening devices include noise-making propane cannons and shot shells, “eye spot” balloons, flags, remote-control boats, heron or owl decoys, and scarecrows. Unfortunately, these birds can become accustomed to these visual devices when used continuously. The use of a large active dog to deter the birds can be highly effective, especially at night. While impractical for some pond owners, physical barriers that may deter the birds include netting, wire or string grids around the pond, and fencing. Deep water (at least 20 inches) at the pond edge will discourage herons and egrets that feed in shallow water.

Waterfowl such as ducks and geese may cause problems if they become too abundant, particularly in small ponds. Although waterfowl can add to the beauty of a pond and feed on some aquatic weeds, they can also muddy the water, damage shoreline vegetation, and the direct deposit or run-off of their waste can increase the nutrients in the pond. These increased nutrients can cause heavy algae blooms, aquatic weed growth, and increase the oxygen demand in the water when the waste decomposes (breaks down). This can increase the possibility of a fish kill. Some of the above techniques may be used to deter them, and a commercial product is available that is sprayed on the grass to discourage geese from feeding.

Pond owners needing assistance with water birds or waterfowl problems can contact your local TWRA or UT Extension office (see pages 44-45). TWRA offices also have lists of Wildlife Damage Control Operators which are licensed by TWRA throughout the state that are in the business of providing landowners, for a fee, with wildlife control and management solutions to their problems. Additional information on ways to reduce any damage caused by wildlife is available from the U.S. Department of Agriculture – Wildlife Services (USDA-WS) at 615-736-5506.

### ***Muskrats***

Muskrats will occasionally invade a pond, and while they pose no problems to the fish population, these burrowing animals become a nuisance when they burrow into the dam or banks (shoreline) of the pond. Burrows along the banks (entrance just below water level) can cause the bank to collapse. Whereas a muskrat will usually not burrow through a dam built according to NRCS recommendations (see *Dam construction*, page 3), excess burrowing and tunneling can eventually weaken the dam and cause leaks or dam failure. Since muskrats feed on aquatic vegetation such as cattails, rushes, water lily, pondweeds, and willows, removing these food sources may discourage them from taking up residence in the pond. See *Aquatic weed control* (14-18). If burrows are found, usually when the water level drops, they can be plugged with rip-rap (6 inch or larger rock) or other fill material as this helps reduce damage, and may discourage them from staying. Sections of chain link fencing and/or rip-rap can be placed along the bank or dam to discourage burrowing. The fencing or rip-rap should extend from about three feet below the water level to two feet above. While not always feasible, fencing off the entire pond can deter muskrats and other wildlife from invading the pond. When muskrats become a nuisance, and the above methods do not force them to leave, they should be removed. Both trapping and hunting can be used to remove them, and the pond owners can check the TWRA *Hunting and Trapping Guide* (or contact your TWRA office) to see when muskrats are in season, the legal equipment and specific regulations. Muskrats are easily trapped, so this method is usually preferred. Traps that can be used for muskrats are available at hunting and sporting goods stores. Leg-hold and Conibear-type traps should be placed at the entrance of burrows or on the trails created by muskrats. Live cage traps can also be used near muskrat trails, and should be well camouflaged and baited with an attractant such as apples. The most effective time to hunt muskrats is early in the morning or late in the evening.

Muskrats which are causing property damage can be removed at any time of the year, but pond owners should contact a TWRA wildlife officer (see page 44) before trapping or hunting these animals out of season. All muskrats that are trapped alive must be destroyed on-site and not transported and released in other areas.

Pond owners not wanting to remove muskrats themselves may contact a lo-

Traps should not be used where domestic pets may be present.



***Muskrat***



cal trapper or a Wildlife Damage Control Operator to remove them. Contact a TWRA office for a list of Wildlife Control Operators or for further information. See *Seeking assistance* (44). Additional information on ways to reduce any damage caused by wildlife is available from the U.S. Department of Agriculture – Wildlife Services at 615-736-5506.

### **Beavers**

Occasionally, beavers take up residence in ponds and can cause considerable damage from their digging activity in the pond banks and/or the dam. They can often block drain pipes and dam spillways, by damming them up with limbs and small trees. As with muskrats, trapping is the best way to remove beavers, but hunting them can also be done. Beavers which are causing property damage can be removed at any time of the year, but pond owners should contact a TWRA wildlife officer (see page 44) before trapping or hunting these animals out of season. All beavers that are trapped alive must be destroyed on-site and not transported and released in other areas.

Pond owners not wanting to remove beavers themselves may contact a local trapper or a Wildlife Damage Control Operator to remove them. Contact a TWRA office for a list of Wildlife Control Operators or for further information. See *Seeking assistance* (44). Additional information on ways to reduce any damage caused by wildlife is available from the U.S. Department of Agriculture – Wildlife Services at 615-736-5506.

### **Otters**

In some parts of the state, otters can invade ponds and small lakes. Their diet consists primarily of fish, and depending on factors such as the number of otters, how long they stay, and the size of the pond, the quantity of fish consumed can be high. However, otters usually do not cause serious problems in bass/bluegill ponds because of the high reproductive rates of these fish species. Small catfish-only ponds are usually the most affected. Otters may also cause erosion problems from their continuous use of pond banks and the dam. While not always feasible, fencing off the entire pond can deter muskrats and other wildlife from invading the pond. As with muskrats and beavers, trapping and hunting can be used to remove otters, **but all otters harvested must be tagged by the harvester with Tennessee U.S. CITES tags.** Contact your nearest TWRA regional office for more information. See *Seeking assistance* (44). Otters which are causing property damage can be removed at any time of the year, but pond owners should contact a TWRA wildlife officer before trapping or hunting these animals out of season. All otters that are trapped alive must be destroyed on-site and not transported and released in other areas.

Pond owners not wanting to remove otters themselves may contact a local trapper or a Wildlife Damage Control Operator to remove them. Contact a TWRA office for a list of Wildlife Control Operators. See *Seeking assistance* (44). Additional information on ways to reduce any damage caused by wildlife is available from the U.S. Department of Agriculture – Wildlife Services at 615-736-5506.

### **Frogs**

Frogs are present in most ponds, and along with tadpoles, provide another food source for fish. Because of this, frogs seldom become overpopulated in ponds with balanced fish populations. A heavy crop of frogs or tadpoles in ponds more than one year old indicates a lack of bass, and may offer poor fishing.

### **Turtles**

Turtles can take up residence in many ponds, but most are mainly scavengers, eating vegetation and dead or diseased fish, and are very seldom bad for the fish population. They may be a nuisance by stealing fishing bait or fish from stringers left in the water. Also, if turtles become too abundant in a pond, their activities on the pond bottom can make the water muddy. Snapping turtles are not as harmful to fish populations as is generally believed. Although they do prey upon small fish and young ducklings, they prefer to eat dead or dying fish in the pond.

If the pond owner needs to reduce the turtle population, several methods can



*Beaver*

*Photo by Jim Johnson*

be used. The box trap is effective for trapping turtles that like to bask in the sun (see *Building a turtle box trap* below). This trap should be placed near the area where the turtles normally bask in the sun. Turtles can also be captured using baited bank lines and trot lines (with stout hooks) baited with raw meat or fish. Hoop-net type turtle traps, set with the top of the trap out of the water, can also be effective when baited with raw meat such as fish or chicken. Floating turtle traps and hoop-net type turtle traps are available from many commercial net companies. Turtles should be trapped in spring, summer or early fall because they are inactive in the winter. Pond owners not wanting to remove turtles themselves may wish to contact a local trapper or a Wildlife Damage Control Operator to remove them. Contact a TWRA office for more information or for a list of Wildlife Control Operators. See *Seeking assistance* (44). Additional information on ways to reduce any damage caused by wildlife is available from the U.S. Department of Agriculture – Wildlife Services at 615-736-5506.

### ***Building a turtle box trap***

Construct a 4-foot frame with pressure-treated 2x4s. This size is easy to handle and can still trap many turtles. The sides and bottom of the frame should be covered with galvanized chicken wire or hardware cloth wire.

Next install the tilt board. When a turtle crawls out onto the tilt board to get the bait, its weight will tip the board down, and it will fall into the trap. The tilt board should be a 1x12 cut to 23 inches. Attach two, ½-inch conduit straps to the bottom of the tilt board with the center of each strap 12 inches from one end. Run a 4½-foot, ½-inch threaded rod through the conduit straps and secure the rod's ends to the top of the frame 12 inches from the end of the tilt board that will rest on the frame. (Use conduit straps, ½-inch nuts and washers to secure the rod.) The tilt board should revolve freely around the threaded rod and one end should rest on top of the frame. A counterweight may be added if the tilt board does not easily return to the horizontal position after it has been tilted. If a counterweight is needed, nail a block of wood to the bottom of the frame end of the tilt board. Also, nail a string from the frame to the bottom of the tilt board to keep it from flipping over completely.

The lead-in ramp, a 24-inch 1x12, should have one end nailed to the top of the frame so it leads onto the tilt board. The end of the lead-in ramp that sticks into the water should be nailed to a 3-foot, 2x4 support board that is nailed to the bottom of the frame. The angle of the ramp should be 45°. If the angle is too steep, turtles will not be able to climb it. If the lead-in ramp is not steep enough they may not climb out onto the tilt board.

Long (20 penny) nails should be nailed every four inches along the inside of the frame near the top so turtles cannot climb out. Bait can be attached to a string or wire that is strung across the nails. The box trap should be set on posts or attached to sealed PVC pipes or other flotation material so it sticks/floats about one foot above the water. Traps should be removed from the water, dried out and stored in the winter.

***Bottom view of tilt board***

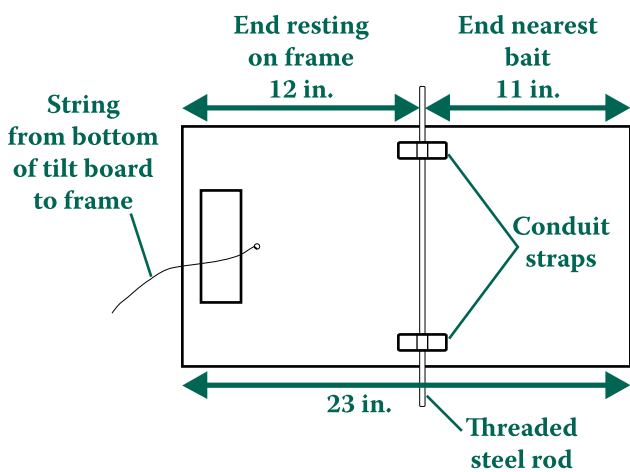

***Turtle box trap***

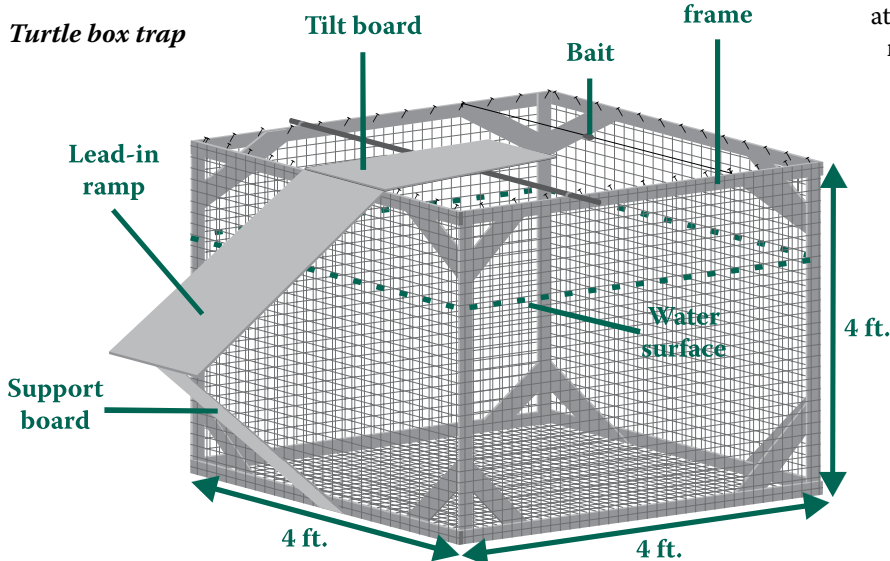

# ALTERNATE STOCKING OPTIONS

## Catfish-only fishing ponds

Pond owners may choose to stock channel catfish alone in ponds either because they prefer the species or because the “catfish-only option” requires the least amount of management. Stocking channel catfish alone is also an excellent option for ponds that cannot support bass and bream because they stay muddy or are smaller than a quarter-acre.

Catfish-only ponds can be stocked at a rate of 100-150 catfish per surface acre without supplemental feeding and aeration, or 300-500 catfish per surface acre with supplemental feeding and aeration. Pond owners can harvest as many catfish as they like whenever the fish grow to an acceptable size. Channel catfish usually do not reproduce in ponds unless special spawning structures are provided, so there is a reduced risk of overcrowding in catfish-only ponds. However, as a precaution, 30-40 largemouth bass fingerlings per acre can be stocked after the catfish to control unwanted spawning and any undesirable fish species that may enter the pond.

At least half of the original stocked fish should be harvested before restocking, so pond owners should keep track of how many fish they harvest. Catfish should be restocked in the fall or early spring and should be 8-10 inches long if largemouth bass are present. Catfish eat fish, insects, worms and some plants, but to increase the growth of the catfish, pond owners may choose to stock fat-head minnows (also known as “tuffies”) for forage at a rate of 8-10 pounds per acre, or feed them a commercial fish fed. See *Feeding fish* (33). Catfish for stocking are available through commercial fish producers. Many of these producers visit county farm and feed stores.

A common mistake pond owners make is stocking too many catfish. In general, no more than 500 pounds of fish per acre should be exceeded without aeration and supplemental feeding. When this poundage is exceeded in ponds without aeration and supplemental feeding, catfish will usually become stressed which will lead to disease in the catfish. In some cases, oxygen can fall below the level for survival and a major fish kill will result.

## Hybrid Sunfish Combinations

The hybrid sunfish is a cross of two different sunfish species, usually a bluegill and a green sunfish. The hybrid sunfish resembles the bluegill, but has a much larger mouth. It is an active feeder and is generally easier to catch than other sunfish. Spawning by hybrid sunfish does occur but is limited because about 90 percent of the hybrids are males.

Stocking hybrid sunfish can offer a good alternative for owners of ponds up to three acres in size. However, it is important for the owner to know that certain conditions are critical and need to be met for the success of ponds stocked with hybrid sunfish.

First, do not stock hybrid sunfish into ponds containing other fish, and never stock them in combination with other bream (bluegill, and redear sunfish) species. The reason for this is because hybrid sunfish will crossbreed with other bream species and hybrid identity and vigor will soon be lost. Second, hybrid sunfish should always be stocked with a predator fish, such as largemouth bass or catfish, to control both the small amount of expected hybrid sunfish reproduction (which is not desirable) and wild fish which may accidentally get into the pond. It is important to remember that hybrid sunfish management is for production of large sunfish, and bass growth will be less than desirable.

Third, periodic restocking of hybrid sunfish will be necessary to sustain the fishery for more than a few years. Pond owners should keep records of the number of hybrids harvested, and restock when 60-75 percent of the original stocked fish have been caught and removed. See *Fish stocking combinations and rates* (6). A fertilization program and/or supplemental feeding can increase the growth of hybrid sunfish. See *Fertilizing your pond* (9) and *Feeding fish* (33).

Channel catfish



Duane Raver/USFWS

TWRA does not supply catfish or hybrid sunfish for stocking into private ponds or lakes but they can be purchased from commercial fish producers.

Hybrid sunfish



Joseph Tomelleri



# POND MEASUREMENT

An approximate measurement of pond size (surface acres) is needed in order to stock the proper amount of fish. Surface acreage, average depth, or acre-feet will also be needed if the pond is to be fertilized, limed, renovated with rotenone, or when applying aquatic herbicides/algacides. Distances in the examples below can be determined by a measuring tape, range finder, or by pacing.

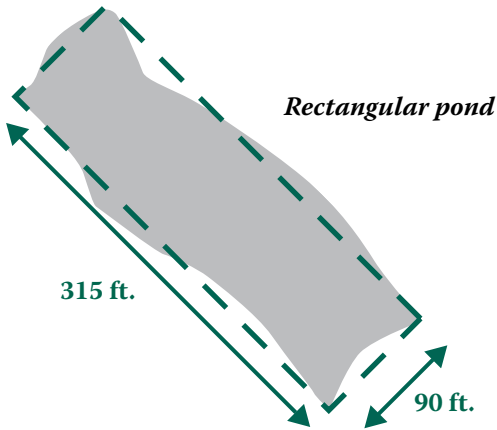

## Determining pond surface acreage

If your pond is basically *square or rectangular*, measure the width of the dam and the length of the pond in feet. Multiply the dam measurement by the length measurement and divide by 43,560 (the number of square feet in an acre).

$$\begin{array}{rcll} \text{For example,} & 90 \text{ ft.} & \times & 315 \text{ ft.} & = & 28,350 \text{ sq. ft.} \\ & (\text{dam width}) & & (\text{pond length}) & & \\ & 28,350 \div 43,560 & = & .65 & \text{surface acres} & (\text{round up two decimal places}) \end{array}$$

If your pond is nearly square or rectangular, you can approximate its size by “boxing it in” so the water outside the rectangle is about equal to the land inside the rectangle. Using this method to determine pond length and width, you can follow the formula above to determine the pond’s surface acres.

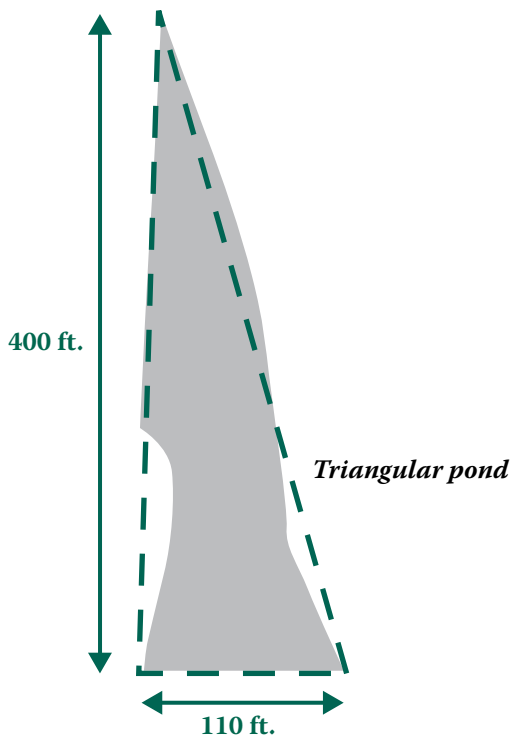

If your pond is more *triangular*, measure the width of the dam in feet, then multiply by the length of the pond in feet. Divide this number by two, then divide by 43,560 to determine the surface acres.

$$\begin{array}{rcll} \text{For example,} & 110 \text{ ft.} & \times & 400 \text{ ft.} & = & 44,000 \text{ sq. ft.} \\ & (\text{dam width}) & & (\text{pond length}) & & \\ & 44,000 \div 2 & = & 22,000 & \div & 43,560 & = & .51 & \text{surface acres} & (\text{round up two decimal places}) \end{array}$$

If your pond is basically *circular*, computing the surface acres is more complicated. First, measure the distance in feet from one side of the pond to the other across the center point of the pond. Divide this measurement by two to determine the radius of the pond. Multiply the radius measurement by itself, then multiply by 3.14. Then, divide this number by 43,560.

$$\begin{array}{rcll} \text{For example,} & 255 \text{ ft.} & \div & 2 & = & 127.5 \text{ ft.} \\ & (\text{pond width}) & & & & (\text{pond radius}) \\ & 127.5 & \times & 127.5 & = & 16,256.25 \\ & 16,256.25 & \times & 3.14 & = & 51,044.625 \end{array}$$

$$51,044.625 \div 43,560 = 1.17 \text{ surface acres (round up two decimal places)}$$

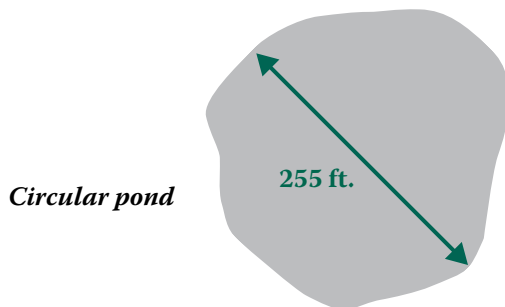

### Determining average pond depth

To determine the average depth of your pond, you need to measure it in numerous, uniformly spaced locations. To make sure you get measurements both in shallow and deep areas, take measurements as you go from shore to shore several times in parallel lines. Then, add the depths of each of the sampled sites together and divide by the number of sites (in this case 8).

- |        |        |
|--------|--------|
| 1. 2.8 | 2. 4.4 |
| 3. 3.2 | 4. 5.6 |
| 5. 3.1 | 6. 5.5 |
| 7. 2.9 | 8. 6.0 |

**Total 33.5**

$$33.5 \div 8 = 4.1875 \text{ ft. average pond depth}$$

### Determining water volume (acre-feet)

The volume of water in a pond is expressed in acre-feet. To determine the volume of water in your pond, multiply the average pond depth (in feet) and surface area (in acres) together.

In the previous example, average pond depth was determined to be 4.1875 ft. The same pond is 0.49 surface acres (130 ft. x 165 ft.).

$$4.1875 \text{ ft.} \times 0.49 \text{ surface acres} = 2.051 \text{ acre-feet}$$

### Other Useful Conversion Factors

1 acre = 43,560 square feet = 4,840 square yards = a square with approximately 209 feet on each side

1 acre-foot of water = 325,850 gallons = 2,718,144 pounds = 43,560 cubic feet

1 gallon of water = 8.34 pounds = 4 quarts = 8 pints

1 pint = 2 cups = 16 fluid ounces

1 pound = 16 ounces = 454 grams

1 tablespoon = 3 teaspoons = ½ ounce

1 part per million (ppm) = 2.7 pounds per acre-foot of water = 0.0038 grams per gallon of water = 0.0283 grams per cubic foot of water

1 percent (%) solution = 1.3 ounces per gallon = 38 grams per gallon

Approximate gallons of water in a pond = length(ft) x width (ft) x average depth (ft) x 7.48

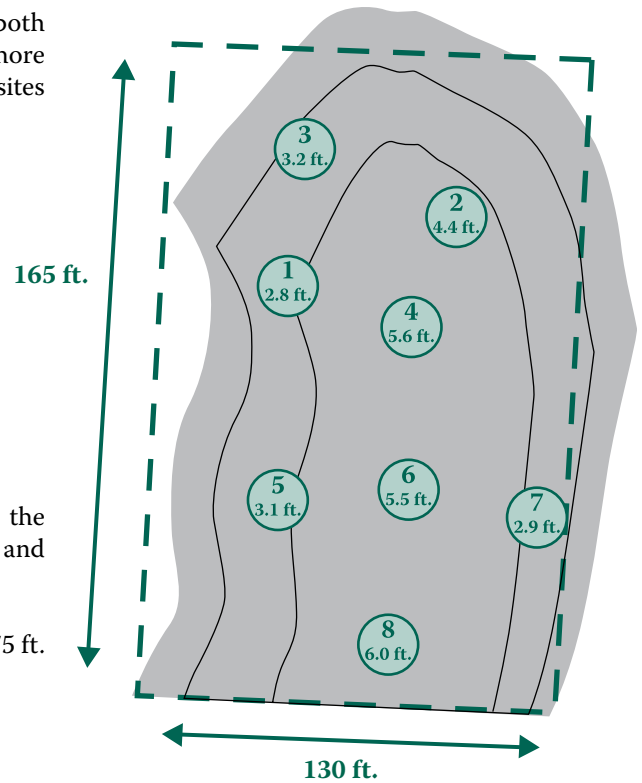

**Sample sites to determine pond depth**

# SEEKING ASSISTANCE

## TENNESSEE WILDLIFE RESOURCES AGENCY OFFICES

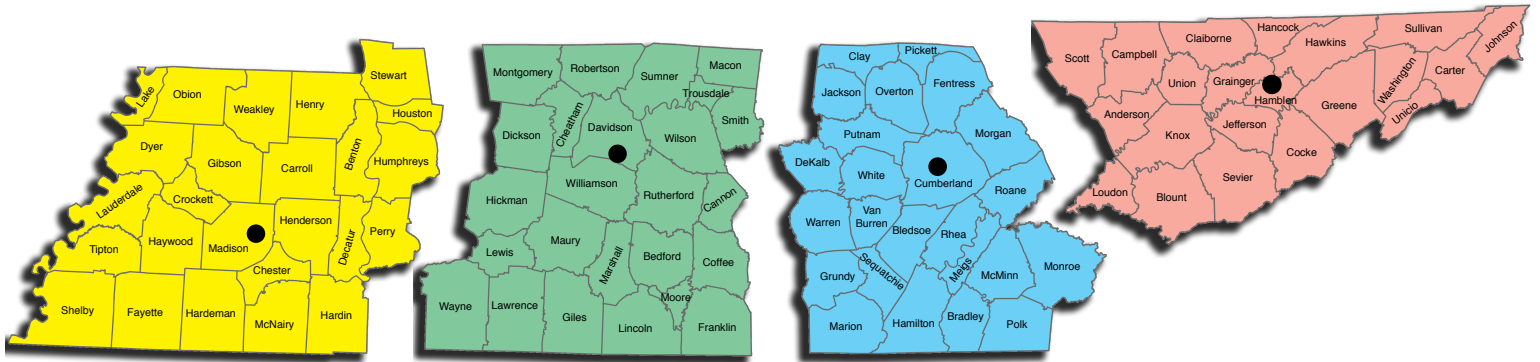

*All offices open Monday through Friday, 8 a.m. to 4:30 p.m. (local time)*

*Visit TWRA's Web site at [www.tnwildlife.org](http://www.tnwildlife.org)*

### ***West Tennessee – Region I***

200 Lowell Thomas Drive  
Jackson, TN 38301  
Phone: 731-423-5725  
Toll-free: 800-372-3928 (In State only)  
Fax: 731-423-6483

### ***Middle Tennessee – Region II***

Ellington Agricultural Center  
5105 Edmondson Pike  
Nashville, TN 37211  
Phone: 615-781-6622  
Toll-free: 800-624-7406 (In State only)  
Fax: 615-831-9995

### ***Cumberland Plateau – Region III***

464 Industrial Blvd.  
Crossville, TN 38555  
Phone: 931-484-9571  
Toll-free: 800-262-6704 (In State only)  
Fax: 931-456-1025

### ***East Tennessee – Region IV***

3030 Wildlife Way  
Morristown, TN 37814  
Phone: 423-587-7037  
Toll-free: 800-332-0900 (In State only)  
Fax: 423-587-7057

### ***Central Office***

Ellington Agricultural Center  
5107 Edmondson Pike  
Nashville, TN 37211  
Phone: 615-781-6575  
Fax: 615-781-6667



*UNIVERSITY OF TENNESSEE EXTENSION OFFICES*



***Western Region***

605 Airways Boulevard  
Jackson, TN 38301-3201  
Phone: (731) 425-4725  
Fax: (731) 425-4729

***Central Region***

5201 Marchant Drive  
Nashville, TN 37211-5112  
Phone: (615) 832-6550  
Fax: (615) 832-0043

***Eastern Region***

3213 Alcoa Highway  
Knoxville, TN 37996-4534  
Phone: (423) 577-9963  
Fax: (423) 573-6626

***UT Extension Soil Testing Center (Nashville)***

Phone: (615) 832-5850

***OTHER RESOURCES***

***U. S. Army Corps of Engineers***

For permit questions:

Nashville District.....(615) 736-7161  
Memphis District .....(901) 544-3005

***Natural Resources Conservation Service (NRCS)***

For your local NRCS office, call the central office in Nashville at (615) 277-2531.  
Local offices may also be found by looking in the U. S. Government section (blue pages) of your phone book.

Web site..... <http://www.tn.nrcs.usda.gov>

***Tennessee Department of Environment and Conservation (TDEC)***

For permit questions:

Toll-free..... 1-888-891-8332  
Web site..... <http://state.tn.us/environment/permits>

# INDEX

## A

aeration 18, 29, 30, 33, 35, 36, 41  
agricultural lime 13, 35  
algae (nuisance) 10, 12, 13, 14, 16, 18  
algal bloom (*see phytoplankton bloom*)  
algcides (defined) 16  
algcides (when to apply) 16, 29  
alkalinity 9, 11, 13, 16, 36  
alternate stocking options 41  
applying for and getting fish from TWRA 5  
applying herbicides and algcides 16  
applying rotenone 27  
aquatic food web 9  
aquatic weed control 14  
aquatic plants (nuisance) 12, 14, 15, 16  
attached algae 16  
attractors (*see fish attractors*)  
avoiding construction mistakes 1  
avoiding livestock or crop fields 1  
avoiding aquatic weed growth 14  
avoiding overcrowding 20

## B

balance (defined) 14  
balance 2, 4, 7, 8, 12, 14, 20, 21, 22, 23, 24, 26, 28, 30, 31, 37, 39  
bass (harvesting) 20, 21, 22, 23, 24  
bass-crowded ponds 20, 22, 24  
bass spawning 20  
beavers 39  
bentonite (in leaky ponds) 34  
biological control with grass carp 7, 17, 19  
biological control with tilapia 17, 18  
biological control of aquatic plants and algae 17, 18, 19  
birds (water) 37  
black bullhead 8  
black crappie 8  
bloom (*see phytoplankton bloom*)  
bluegill 6  
bluegill-crowded ponds 20, 23, 24  
bluegill/redear sunfish 6  
bluegill/redear sunfish harvesting 21, 22, 23, 24  
bluegill/redear sunfish stocking rates 6  
bluegill spawning 6, 7  
bluegill stocking rates 6  
bluestone 16, 19  
bottom (pond) 4  
bream 6  
brush piles 4  
bullheads (yellow and black) 8

## C

calcium carbonate 13, 35, 36  
carp, common (*also see grass carp*) 24, 27, 35, 37  
carrying capacity (defined) 9, 21  
catch-and-release fishing 20, 22  
catfish-only fishing ponds 41  
catfish (*see channel catfish*)  
cattail 14, 15, 26, 38  
cattle (*see livestock*)  
causes of unproductive fishing ponds 26

causes of muddy water 35  
channel catfish 6, 7, 8, 22, 35, 41  
channel catfish harvesting 22  
channel catfish stocking combinations 6, 7  
channel catfish stocking rates 6, 7, 41  
chara 16, 19  
chelated copper 15, 16, 19  
chemical control of nuisance algae 16  
chemical control of aquatic weeds 15, 16  
chemical removal of unbalanced fish populations 26  
chemicals (regulation of) 15  
chlorinated water 29  
city water 29  
clear water 16, 35, 36  
construction (pond) 1, 2, 3, 4, 34  
copper compounds (and fish kills) 13, 16  
copper compounds (*see chelated copper*)  
copper sulfate 16, 19  
cottonseed meal 36  
crappie (black and white) 8

## D

dam construction 3  
depth (pond) 2, 43  
determining average pond depth 43  
determining pond surface acreage 42  
determining water volume 43  
diseases and parasites 30  
dissolved oxygen 28  
drainage area 2  
drainage into lake or pond 2  
draining pond 26  
drain pipes 3  
drawdown 15, 25  
duckweed 14, 15, 19, 29

## E

earthen piers 4  
emergent aquatic plants 14, 15  
eradication of unwanted fish 27  
evaluating pond balance 23, 24  
existing fish in pond 5

## F

feeding fish 33  
fertilization platforms 10, 11  
fertilization rates (Table 1) 11  
fertilized ponds (harvesting rates for) 21  
fertilizer (granular) 10  
fertilizer (powdered) 10  
fertilizer (liquid) 10  
fertilizer (time-released granular) 10  
fertilizing 9  
fertilizing (in ponds where fish are fed) 12  
fertilizing (when not to) 12  
fertilizing (when to) 11  
fertilizing with phosphate alone 10  
filamentous algae 12, 14, 16, 18, 29  
fish attractors 4  
fish combinations for stocking 6  
fish-eating birds 31, 37

fish harvesting 9, 12, 18, 20, 21, 22, 23, 24, 33, 41  
 fish kills 9, 4, 13, 25, 28  
 fish kills (sign of) 28  
 fish population balance (*see balance*)  
 fish population overcrowding 20  
 fish population sampling 20  
 fish you should NOT stock 8  
 fish (wild) 4, 5, 30, 37, 41  
 fishing log 28  
 fishing piers 4  
 floating aquatic plants 14, 15, 19  
 frogs 39

**G**

gatevalve 3  
 gizzard shad 8  
 golden shiner 8  
 granular fertilizer 10  
 grass carp (biological control with) 7, 17, 19  
 grass carp (sterile) 17  
 grass carp (triploid) 17  
 grate (trash rack) 3, 4  
 gravel beds 4  
 gravity-fed drain pipe 1  
 grubs on fish 31  
 gypsum (agricultural) 35

**H**

habitat 4  
 harvesting channel catfish 22  
 harvesting fish 13, 20, 21, 22, 23  
 harvesting fish (recommended rates) 20, 21, 22, 23, 24  
 hatchery fish 5, 8, 17  
 hatchery fish application 5  
 hatchery fish delivery 5  
 herbicide use regulations 16  
 herbicides 1, 14, 15, 16, 17, 19, 28, 29  
 how and when to lime 13  
 how to feed 33  
 hybrid sunfish 6, 41  
 hydrated lime (and fish kills) 13

**I**

identifying plants 14

**K**

kills (fish) 9, 4, 13, 25, 28

**L**

label instructions (following) 10, 11, 15, 16, 19, 26, 27  
 largemouth bass 5, 6, 7, 8, 17, 18, 22, 35, 37, 41  
 largemouth bass and bluegill/redear sunfish 6  
 leaking ponds 2, 34  
 leaks (avoiding) 2, 34, 38  
 lime (agricultural) 13, 35  
 lime (and fish kills) 13  
 limestone 13  
 liming 13  
 liming (when to) 13  
 liquid fertilizer 10  
 livestock 1, 4, 14, 26, 28, 29, 35, 37  
 livestock and wildlife in fishing ponds 37

**M**

managing fish populations 20  
 maintaining balance after a fish kill 31  
 measuring pond size 5, 42, 43  
 miscellaneous considerations 34  
 monitoring pond balance 22, 23  
 monitoring pond balance by angling (fishing) 23  
 monitoring pond balance by seining 22  
 moss (*see filamentous algae*)  
 mudcats (*see bullheads*)  
 muddy water 8, 12, 26, 29, 35, 36, 37, 38, 39, 41  
 muddy water (causes of) 35  
 muskgrass (*see chara*)  
 muskrats 38

**N**

naiad (Southern) 14, 15, 19  
 nitella 16  
 nuisance algae 10, 12, 13, 14, 16, 18  
 nuisance aquatic plants 12, 14, 15, 16

**O**

otters 39  
 overcrowded fish population 2, 6, 7, 8, 12, 20, 21, 23, 24, 25, 30  
 overcrowded ponds (removing fish from) 24  
 overestimating pond size 5  
 overflow pipes (*see drain pipes*)  
 oxygen deficiencies 2, 4, 9, 12, 16, 28, 29, 30, 33, 35, 36, 41  
 oxygen levels 4, 9, 16, 28, 29, 30, 33

**P**

parasites or diseases (on fish) 30  
 partial removal with chemicals 25  
 partial removal with seines 25  
 partial removal with wire traps 25  
 pesticides 1, 2, 28, 37  
 pets (traps where present) 38  
 pH 13  
 phosphate fertilizer 10  
 physical characteristics (of pond) 26  
 piers 4  
 phytoplankton bloom 9, 10, 12, 13, 14, 16  
 pigs (*see swine*)  
 planktonic algae 8, 10, 12, 16, 19  
 platforms for fertilization 10  
 polywogs (*see bullheads*)  
 pond balance (*see balance*)  
 pond building contractors 1  
 pond construction 1  
 pond depth 2  
 pond depth, bank slope and shoreline depth 2, 3  
 pond measurement 42, 43  
 pond production and fish harvest 21  
 pond scum (*see filamentous algae*)  
 pond size 1, 42  
 powdered fertilizer 10  
 primrose (*see water primrose*)

**Q**

quicklime (and fish kills) 13



# INDEX

## R

rain 12, 28, 29, 35  
reclaiming unproductive ponds 26  
redeer sunfish 3, 6, 7, 20, 21, 22, 31, 41  
redeer sunfish with bluegill 6  
removing fish from overcrowded ponds 24  
restocking fish 17, 20, 25, 26, 27, 31, 41  
risks of feeding 33  
rotenone (killing fish with) 25, 26, 27, 31, 35, 37  
runoff 1, 2, 12, 14, 15, 26, 29, 35

## S

sampling fish population 20  
seeking assistance 44, 45  
seines 22, 24, 25, 23, 37  
shad 8  
shallow water 2, 14, 15, 25, 26, 31, 38  
shellcrackers (*see redear sunfish*)  
shoreline depth 2, 3  
sign of fish kills 28  
siltation 2, 26  
site (pond) 1  
size (pond) 1  
slime (*see filamentous algae*)  
slope (bank) 2, 3  
soda ash 2, 34  
sodium carbonate 2, 34  
soil evaluation 1  
soil testing 13  
soil testing and liming ponds under construction 13  
sores on fish 30, 31  
Southern naiads (*see naiads*)  
spawning (bluegill) 6, 7  
spawning (bass) 20  
spillways 4, 17, 39  
stake bed 4  
standpipe 3  
sterile (triploid) grass carp 17  
stock fish (*see hatchery fish*)  
stocking fish 1, 5, 6, 17, 18, 20, 21, 22, 25, 26, 27, 30, 31, 41  
stocking rates 6, 17, 18, 22, 37  
stonewort (*see nitella*)  
streams 1  
streams (chemical use near) 16, 27  
submersed aquatic plants 14, 15, 17, 19  
surfactant (with herbicides) 15  
superphosphate 10, 30, 36  
swine 26

## T

temperature (*see water temperature*)  
tilapia 17  
time-released granular fertilizer 10  
total alkalinity 13, 16, 19  
trap (turtle box) 40  
traps (and domestic pets) 38  
traps (wildlife) 38, 39, 40  
triploid (sterile) grass carp 17  
tuffies 41  
turtle box trap building 40

turtles 39  
types of fertilizer 9, 10

## U

unbalanced 2, 4, 8, 12, 14, 21, 22, 24, 26  
unfertilized ponds (harvesting rates for) 9, 21  
unproductive fishing ponds 26  
unwanted fish (eradicating) 27

## W

water birds 37  
watering trough 1, 3, 4, 35, 37  
watermeal 14, 15, 18, 19  
water primrose 14, 15, 19  
watershed 1, 2, 4, 12, 14, 26, 28, 35, 37  
water temperature 2, 6, 7, 11, 16, 17, 18, 26, 27, 29, 33, 35  
water testing and liming in existing ponds 13  
wetland 1  
when NOT to fertilize 12  
when to fertilize 11  
when to harvest after stocking 22  
when to restock 27  
white amur 7, 17  
white crappie 8  
wild fish 4, 5, 30, 37, 41  
willow 14, 15, 16, 19, 26, 38  
wire traps 25

## Y

yellow bullhead 8

# AQUATIC PLANTS



*Filamentous algae*



*Willow*



*Water primrose*



*Southern naiad or "pondweed"*



*Willow*



*Yellow waterlily*

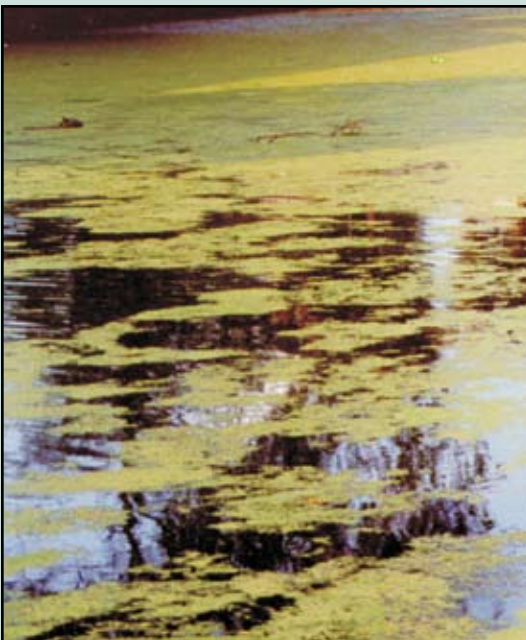

*Duckweed on pond surface*

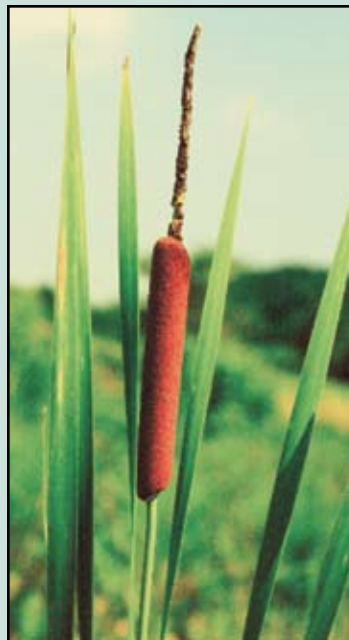

*Cattail*



*Watermeal on pond surface*



